

Mastercam X⁸

TRAINING

GUIDE

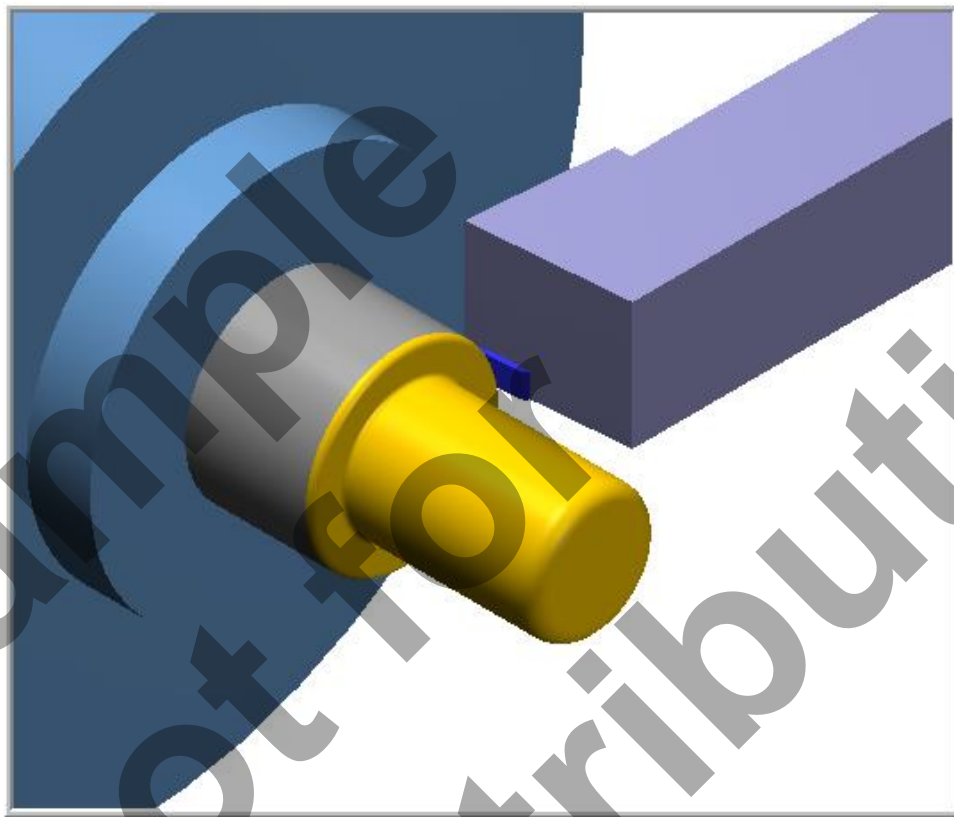

LATHE-LESSON-1

FACE, ROUGH, FINISH AND CUTOFF

camInstructor

Objectives

You will create the geometry for Lathe-Lesson-1, and then generate a toolpath to machine the part on a CNC lathe. This lesson covers the following topics:

➤ **Create a 2-dimensional drawing by:**

Creating lines.
Creating fillets.

➤ **Establish Stock and Chuck settings:**

Stock size.
Chuck Configuration.
Material for the part.
Feed calculation.

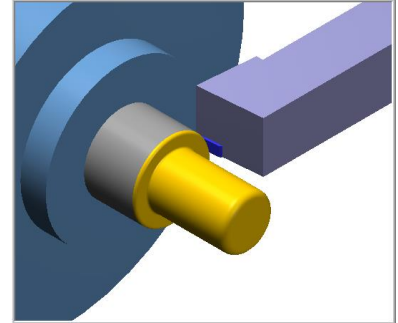

➤ **Generate a 2-dimensional lathe toolpath consisting of:**

Lathe Face.
Lathe Rough.
Lathe Finish.
Lathe Cutoff.

➤ **Inspect the toolpath using Mastercam's Verify and Backplot by:**

Launching the Verify function to machine the part on the screen.
Using Backplot to identify the correctness of the toolpaths.
Generating the NC- code.

Sample
not for
Distribution

LATHE-LESSON-1 DRAWING

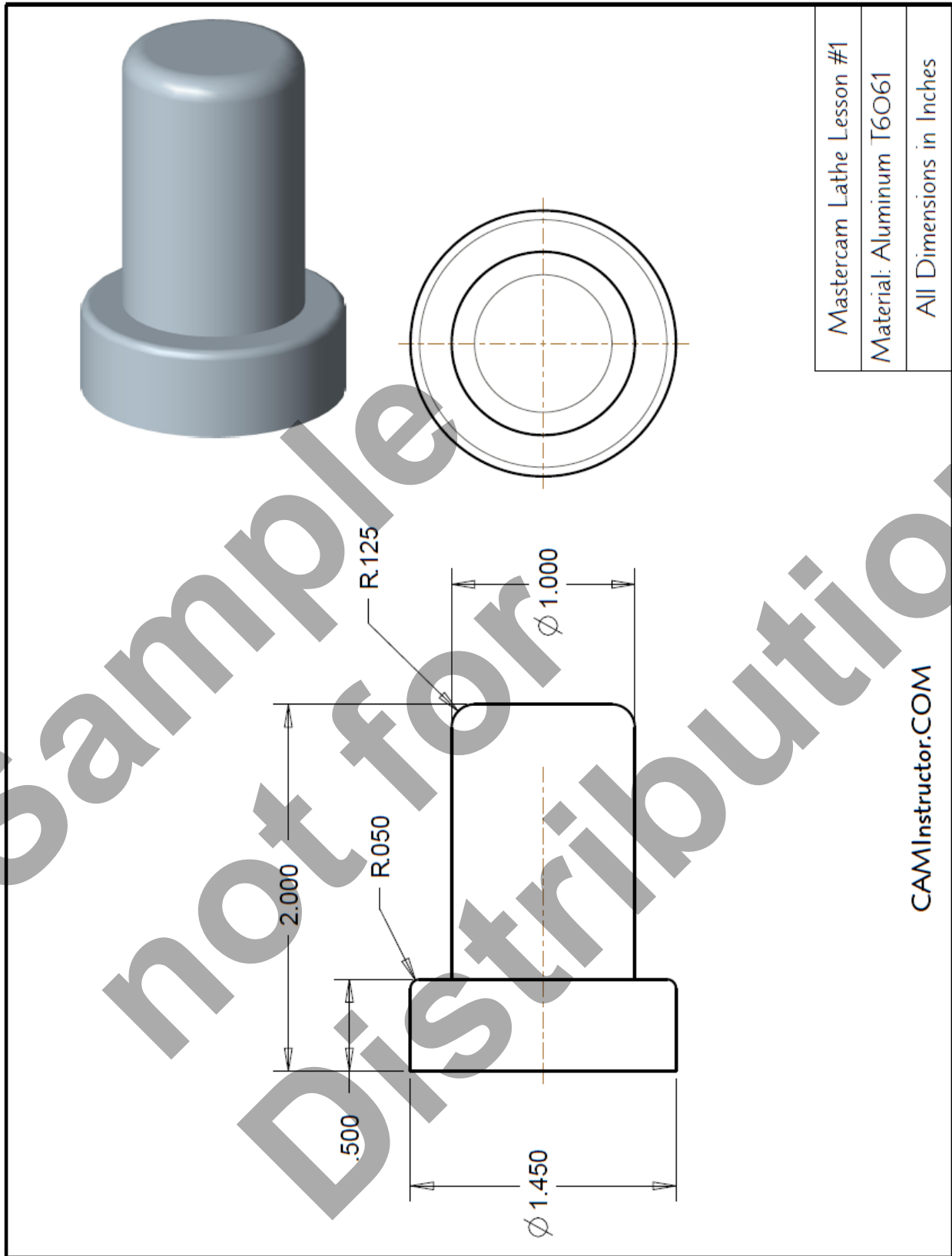

TOOL LIST

Two tools will be used to create this part.

- ☞ **Tool #1 Face, Rough and Finish the outside diameters**
Holder: Outside Diameter Rough Right Hand - DCGNR-164D.
Insert: 80 Degree Diamond Insert – CNMG-432.

- ☞ **Tool #2 Cutoff the part**
Holder: Outside Diameter Cut-off Right Hand.
Insert: 0.125" Wide.

LATHE - LESSON - 1 - THE PROCESS

Geometry Creation

- TASK 1:** Setting the Environment
- TASK 2:** Setting the Construction Planes
- TASK 3:** Create the Geometry
- TASK 4:** Create the Fillets (Radius)
- TASK 5:** Save the Drawing

Toolpath Creation

- TASK 6:** Define the Stock and Chuck Parameters
- TASK 7:** Face the Front of the Part
- TASK 8:** Rough the Outside Diameters
- TASK 9:** Finish the Outside Diameters
- TASK 10:** Cut off the Part
- TASK 11:** Backplot the Toolpath
- TASK 12:** Verify the Toolpath
- TASK 13:** Save the Updated Mastercam File
- TASK 14:** Post and Create the CNC Code File

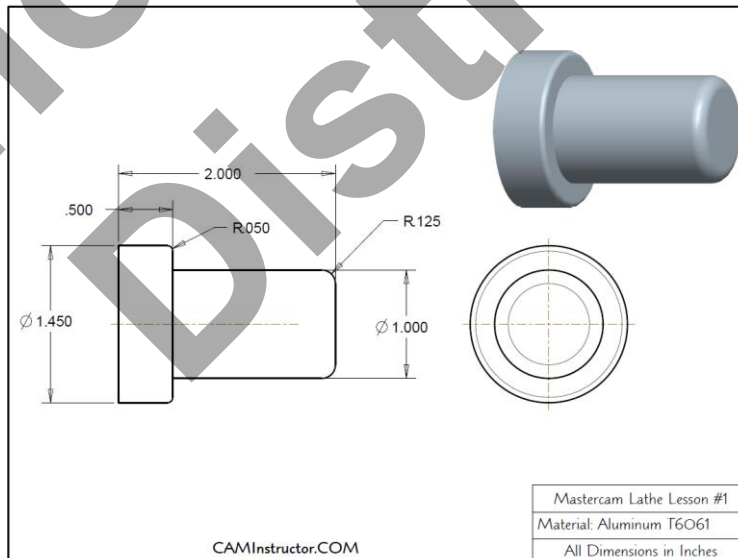

Geometry Creation

TASK 1: SETTING THE ENVIRONMENT

Before starting the geometry creation you should set up the grid and toolbars as outlined in the **Setting the Environment** section at the beginning of this text:

1. Set up the **Grid**. This will help identify the location of the origin.
2. Load the Workspace – **SETTINGS>Load Workspace>Lathe** to machine a part on the Lathe.
3. Set the **MACHINE TYPE** to the **Lathe Default**.

TASK 2: SETTING THE CONSTRUCTION PLANES:

➤ **Set the Construction Plane to Lathe diameter +D +Z (WCS)**

1. Click on **Planes** at the bottom of the screen as shown below:

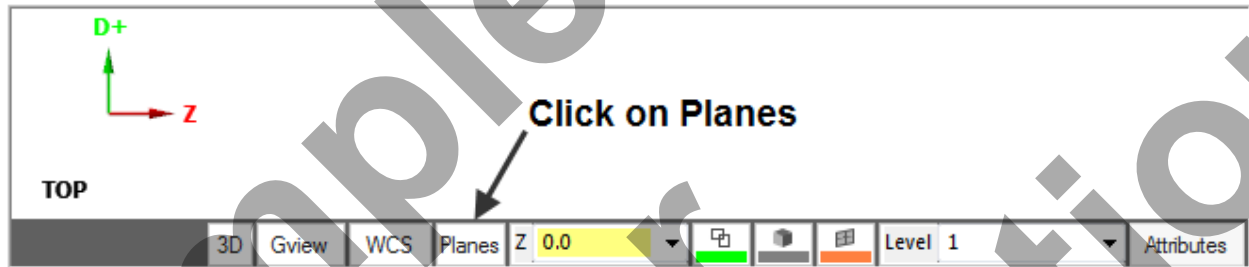

2. Click on **Lathe diameter>+D +Z (WCS)** as shown below:

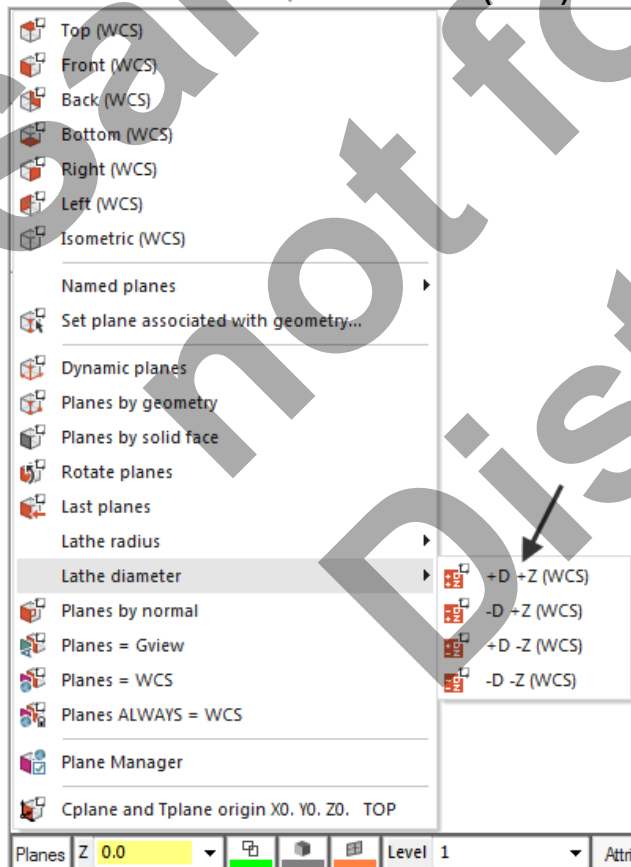

TASK 3:

CREATE THE GEOMETRY – THE RIGHT HAND FACE IS AT Z0

- ☞ This task explains how to create the geometry of this part. In this lathe part you only need to create **half of the geometry**, the geometry above the center line.
- ☞ Lines 1 through 5 will be created first and then the fillet and chamfer will be created.

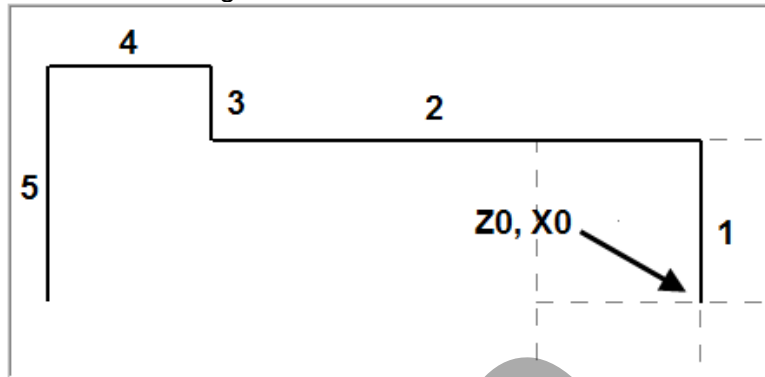

☞ Create Line #1

1. Watch the videos **Lesson-1 - Introduction** and **Lesson-1 - Task 1 to 3**.
2. Select from the pull down menu **CREATE>Line>Endpoint...**

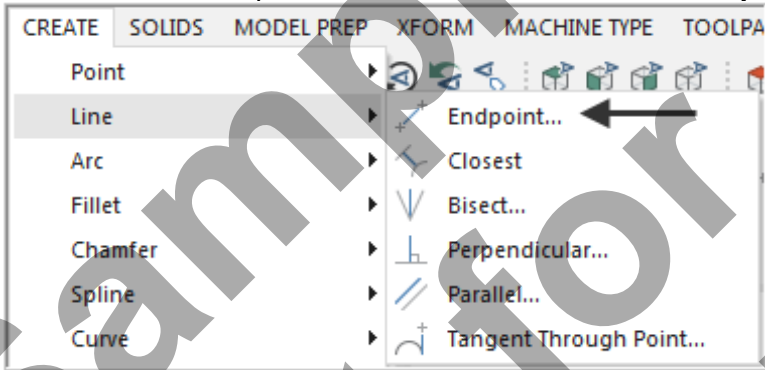

3. The **Line ribbon bar** appears.

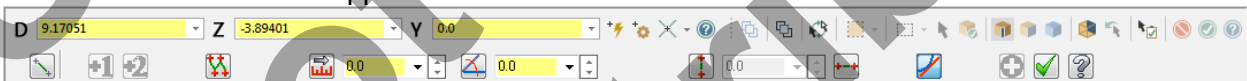

4. Move the cursor over the **center of the grid** and as you get close to the origin a visual cue appears.  With this visual cue highlighted click the **left mouse** button.

☞ The following are Mastercam Visual Cues:

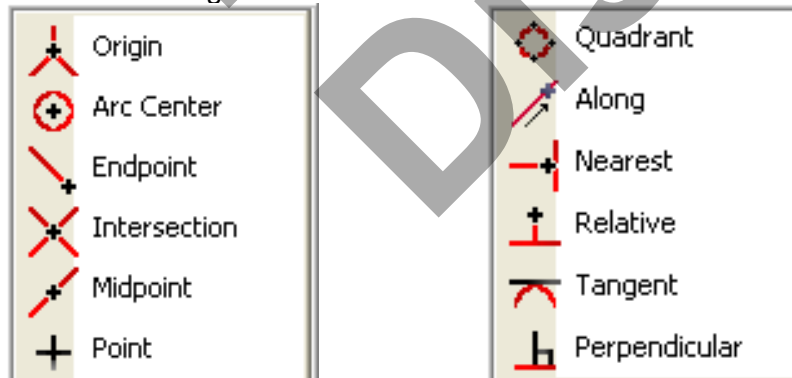



- You are prompted to “Specify the second endpoint”. Click in the **D** value space (Diameter) (as shown by the arrow below) and enter a value of **1.0**. Hit the Enter key and enter a value of **0** for the **Z**, hit the Enter key again. **Note** the value of Y is set to **Zero**, this does not need to be input.

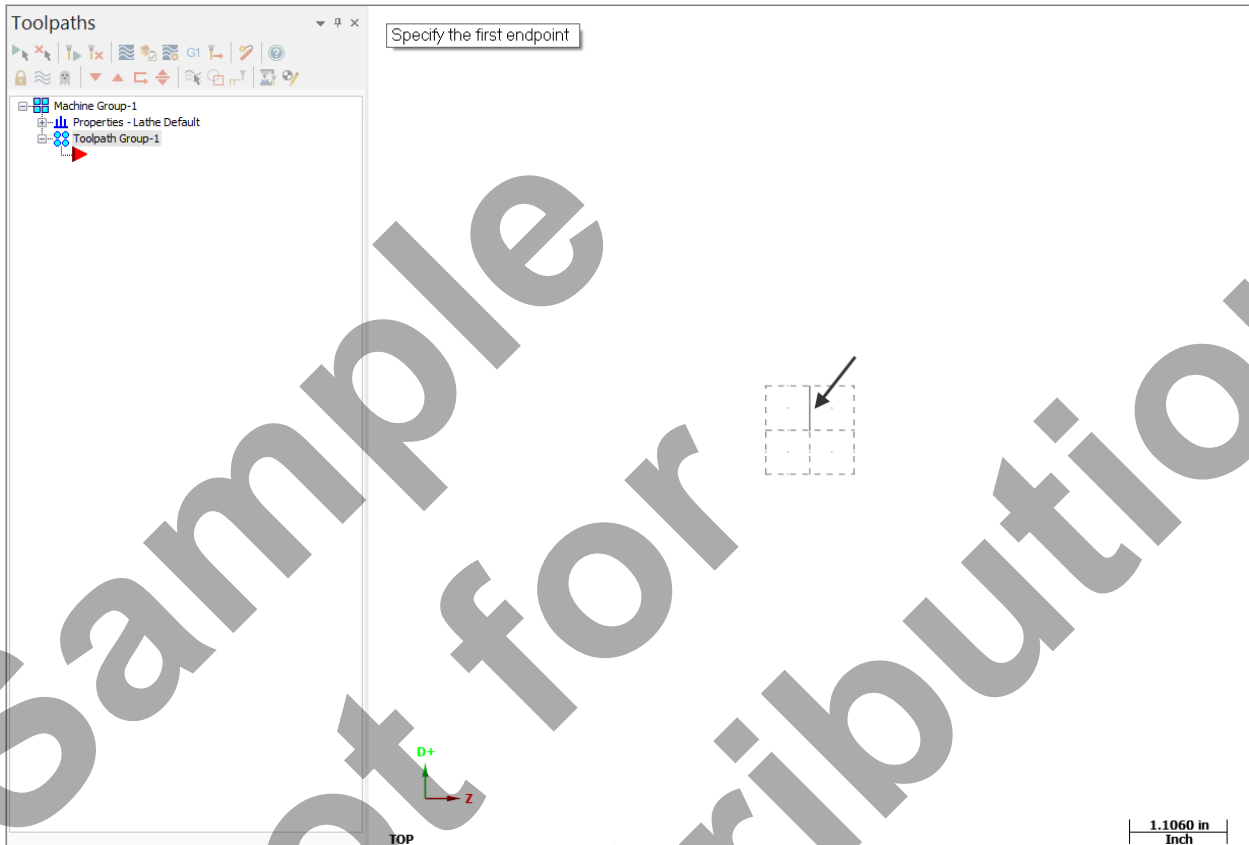

- Click on Apply .
- A **vertical line** should be visible as shown below:



NOTE: If you make a mistake creating lines, click on the **Accept** icon  and click on the **Undo** icon . Then redo the Line.

Mastercam Training Guide

➤ Create Line #2.

8. You are next prompted to **“Specify the first endpoint”**. Click on the **end of the line** that was just created as shown below and as you get close to the end point a visual cue appears.  This is the cue that will allow you to snap to the endpoint of this line. With this visual cue highlighted pick the end point of the line.

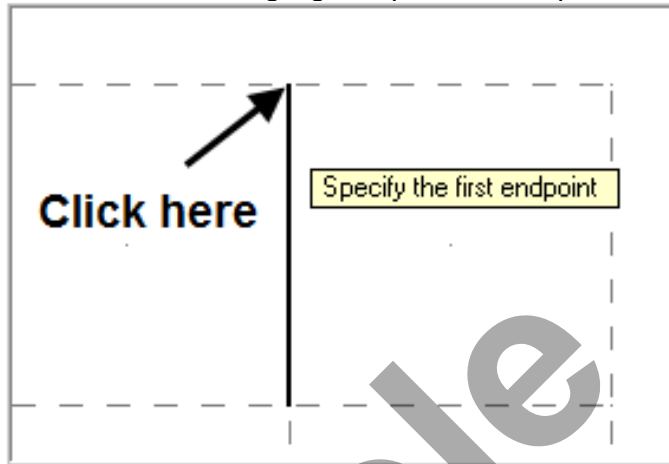

9. You are next prompted to **“Specify the second endpoint”**. On the Line ribbon bar click in the **D** value space and enter **1.0**. Hit the Enter key and enter a value of **-1.5 for the Z**. **Note** the value of Y is set to **Zero**, this does not need to be input. Hit the Enter key once again to complete this line.



10. Click on Accept .

➤ Create Line #3

11. You are next prompted to **“Specify the first endpoint”**. Click on the **end of the line** that was just created as shown below:

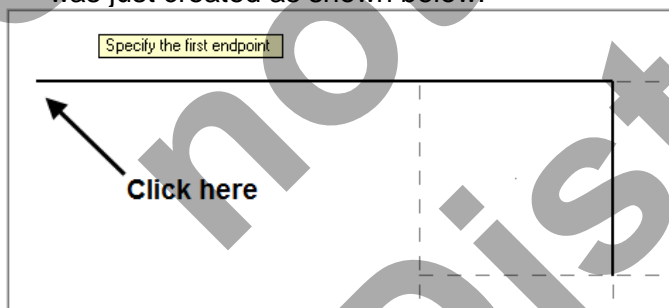

12. You are next prompted to **“Specify the second endpoint”**. On the Line ribbon bar click in the **D** value space (Diameter) and enter a value of **1.45**. Hit the Enter key and enter a value of **-1.5 for the Z**. Hit the Enter key once again to complete this line.

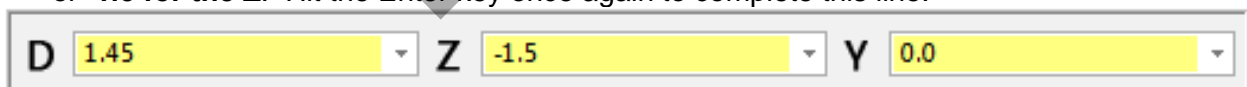

13. Click on Accept .

➤ **Create Line #4**

14. You are next prompted to “Specify the first endpoint”. Click on the **end of the line** that was just created as shown below:

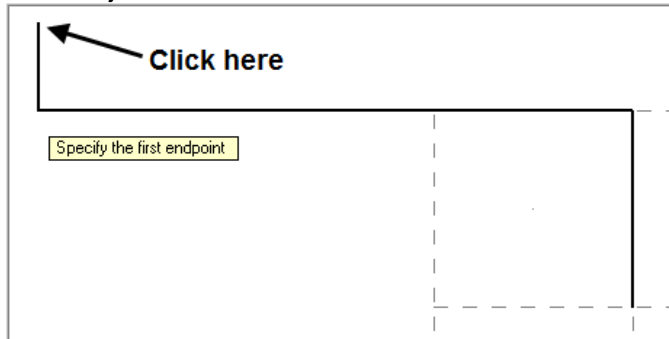

15. You are next prompted to “Specify the second endpoint”. On the Line ribbon bar click in the **D** value space (Diameter) and enter a value of **1.45**. Hit the Enter key and enter a value of **-2.0** for the **Z**. Hit the Enter key once again to complete this line.

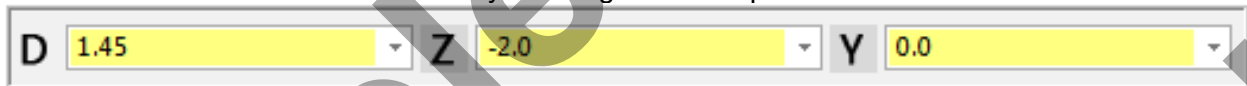

16. Click on **Accept**

17. Fit the image to the screen by clicking on the **Fit to Screen** icon as shown below:



18. Then by clicking on the **Un-Zoom .8** icon as shown below:



Fit

Use this function to maximize your view of visible geometry in the graphics window. When you use this function, the system positions and sizes the displayed geometry to fill as much of the graphics area as possible.

In addition to using the View menu, you can access this function from the right-click menu, from the toolbar, by pressing [Alt+F1], or by pressing the Home key on your keyboard.

Unzoom .8:

This reduces the size of the displayed geometry to 80% of its current size.

Mastercam Training Guide

➤ Create Line #5

19. You are next prompted to **“Specify the first endpoint”**. Click on the **end of the line** that was just created as shown below:

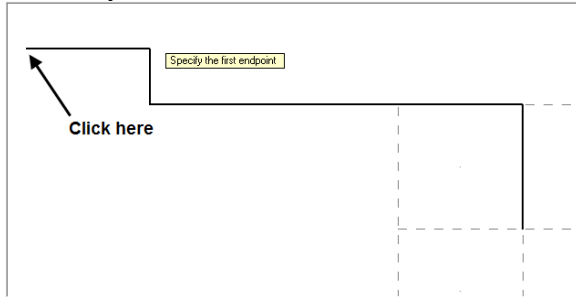

20. You are next prompted to **“Specify the second endpoint”**. On the Line ribbon bar click in the **D** value space (Diameter) and enter a value of **0**. Hit the Enter key and enter a value of **-2.0 for the Z**. Hit the Enter key once again to complete this line.



21. Click on the **OK** icon  to complete this feature.

22. Select the **Screen Fit** icon to fit the part to the screen .

23. Your geometry should look like the figure below:

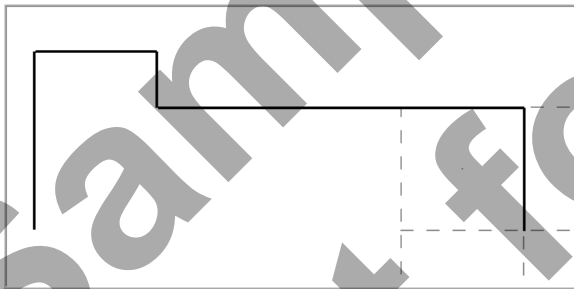

**TASK 4:
CREATE THE FILLETS**

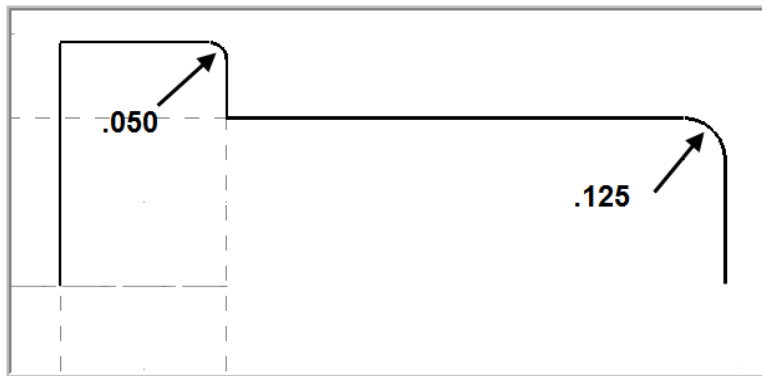

➔ Create the .050 fillet radius.

1. Select **CREATE>Fillet>Entities...**

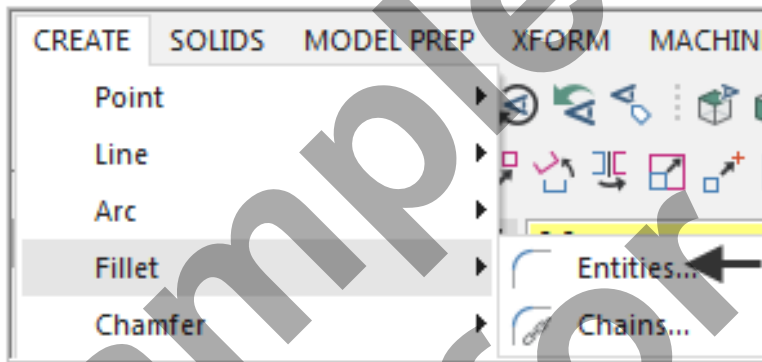

Fillet Entities

Use this ribbon bar to apply fillets to existing entities.

Before selecting the entities to fillet, choose the **fillet style** (normal, inverse, circle, clearance), and enter the desired radius value.

Then choose the first and second entities. Mastercam's auto-preview feature displays a temporary fillet at the selected location.

You can also choose to trim to the fillet or to leave the selected lines untrimmed. **Trimming is the default**, so for no trimming, select the **No Trim** button.

2. The **Fillet Entities** ribbon bar appears and you are prompted to “**Fillet: Select an entity**”.

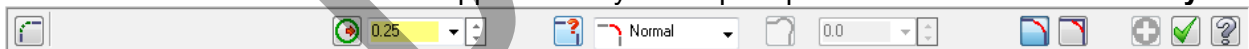

Mastercam Training Guide

- Click in the space for radius and input **.050** and then hit the tab key.



- You are now transported over to the **Fillet Style field**. Click on the drop down arrow to review the various fillet radius styles and then ensure **Normal** is selected before moving on.

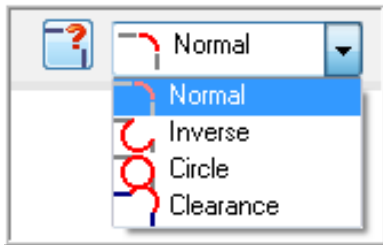

- Ensure the **Trim** option for fillet is activated, the icon is depressed as shown below:



- Click on **line 1** and then click on **Line 2** as shown below:

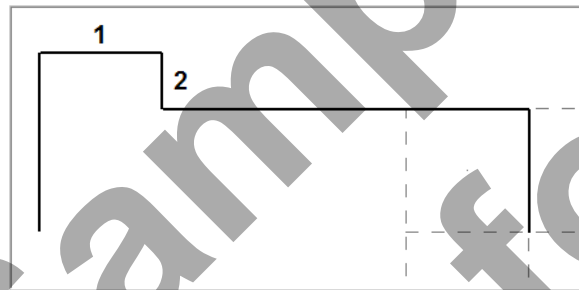

- Click on the **OK** icon to complete this feature.

- The completed fillet is shown below:

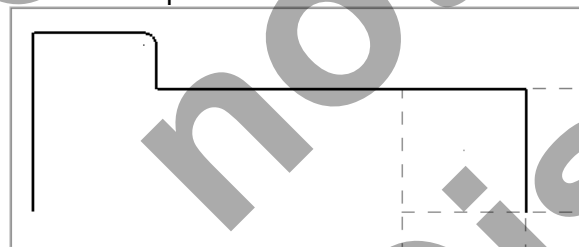

➤ Create the .125 radius

9. Select **CREATE>Fillet>Entities...**

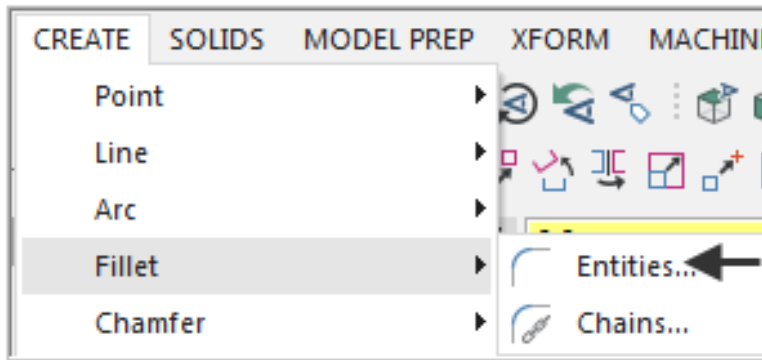

10. The **Fillet Entities** ribbon bar appears and you are prompted to “**Fillet: Select an entity**”.



11. Click in the space for radius and input **.125** and then hit the tab key.



12. You are now transported over to the **Fillet Style field**. Ensure **Normal** is selected before moving on.



13. Ensure the **Trim** option for fillet is activated, the icon is depressed as shown below:



Mastercam Training Guide

14. Click on **Line 1** and then click on **Line 2** as shown below:



15. Click on the **OK** icon  to complete this feature.

16. The completed fillet is shown below:

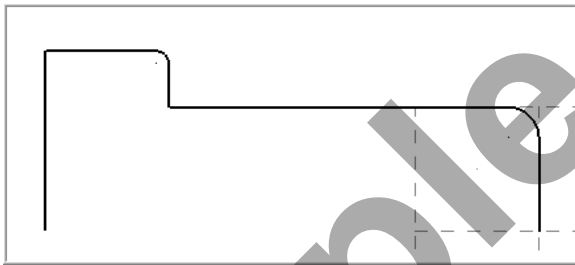

17. This completes the geometry for this part.

TASK 5: SAVE THE DRAWING

1. Select **File**.
2. Select **Save As...**
3. In the “**File name**” box, type **Lathe-Lesson-1**.
4. Save to an appropriate location.
5. Select the Save button to save the file and complete this function.



Toolpath Creation

TASK 6:

DEFINING THE STOCK AND CHUCK PARAMETERS

1. Select the screen Fit icon.



2. Select Un Zoom Previous / .5



3. Ensure your screen looks like the image below:

- The Toolpaths Manager is open, if it is not Select Alt and O on your keyboard to open it.
- The properties icon displays Lathe Default. If it is not turn to the section titled **Setting the Environment** at the beginning of this book.
- The **Lathe - Lesson-1** Geometry is showing.

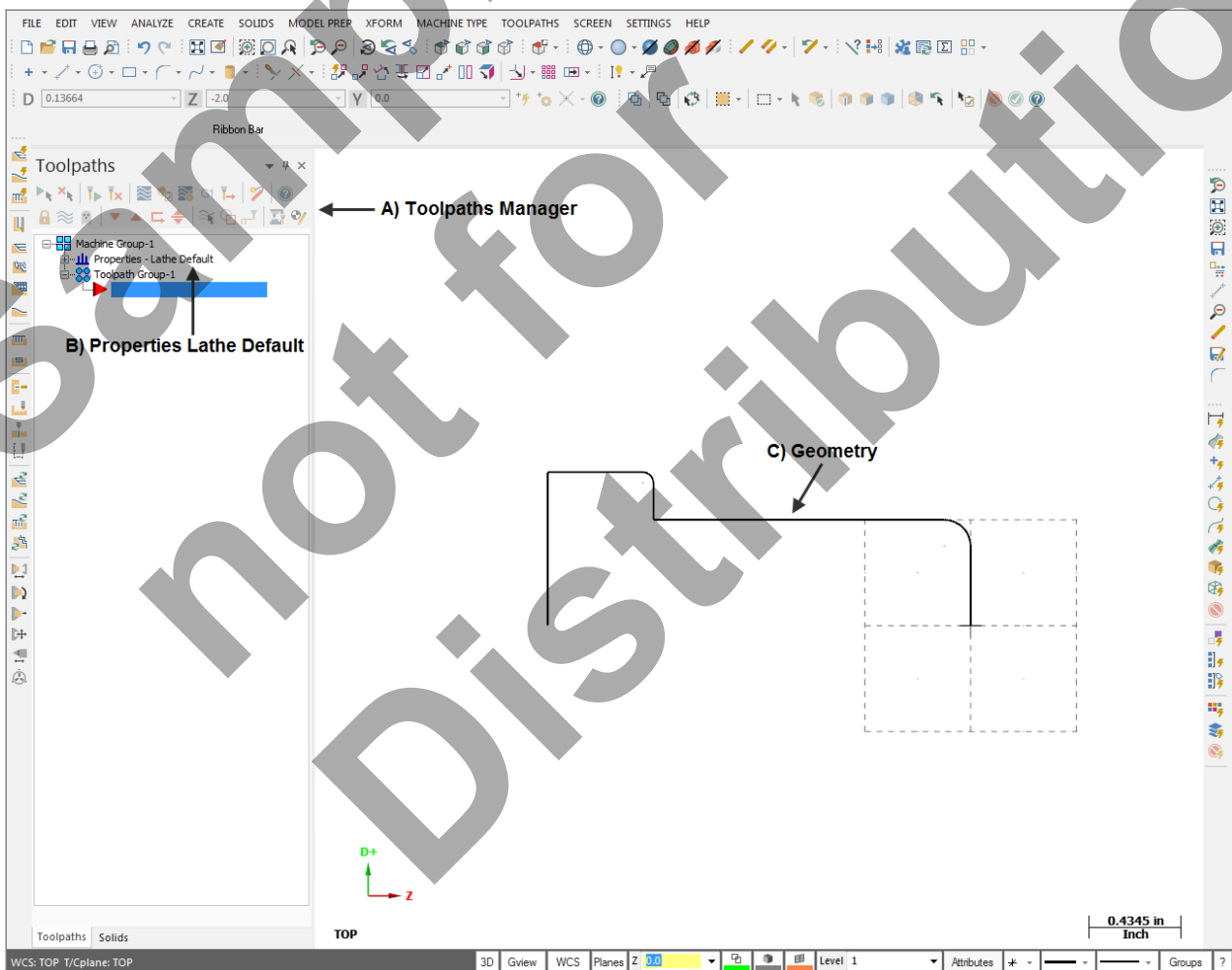

Mastercam Training Guide

4. Select the plus in front of **Properties** to expand the Machine Group Properties.

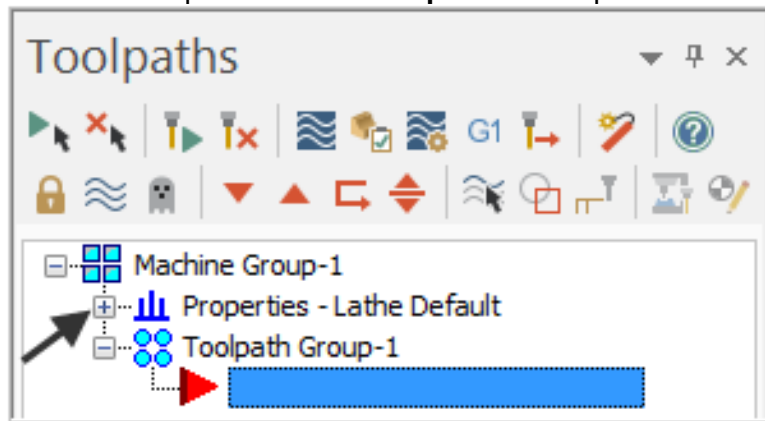

5. **This is optional** - To expand the toolpaths manager window, click on the outside of the window with the left mouse button (hold the button down) and drag it to the right.

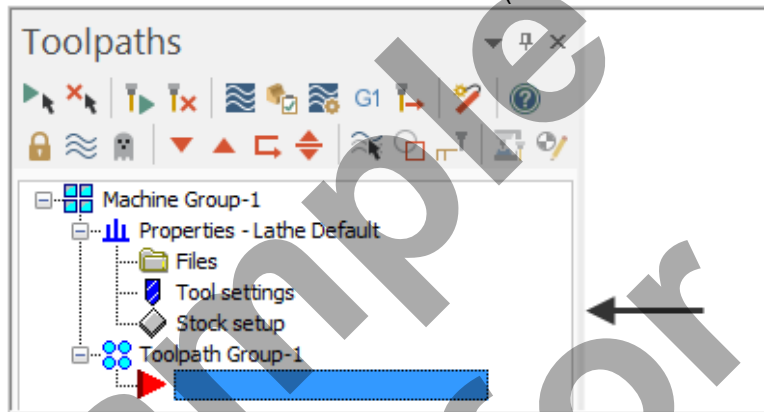

6. Select **Stock setup** in the Toolpaths Manager window.

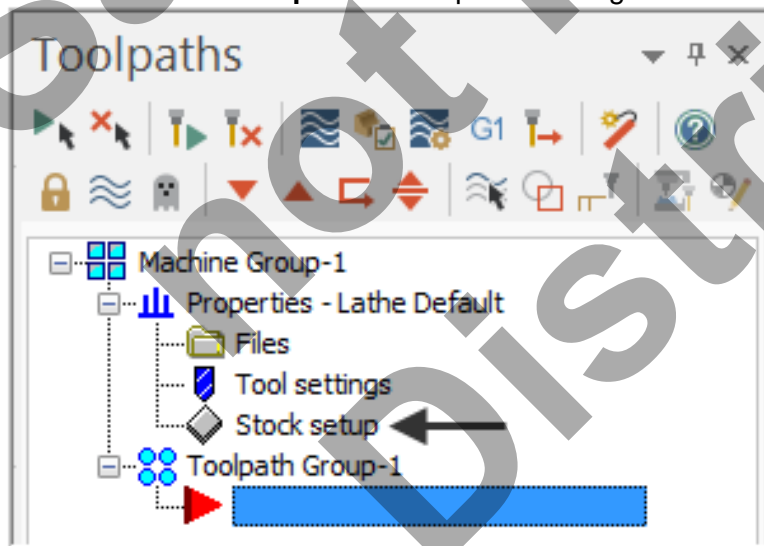

7. Select the **Stock Properties** button in the Stock Setup page as shown in the screenshot below:

Note: To learn more about Stock Setup refer to the Tips and Techniques section on the Mastercam Training Guide – Lathe DVD that accompanies this book.

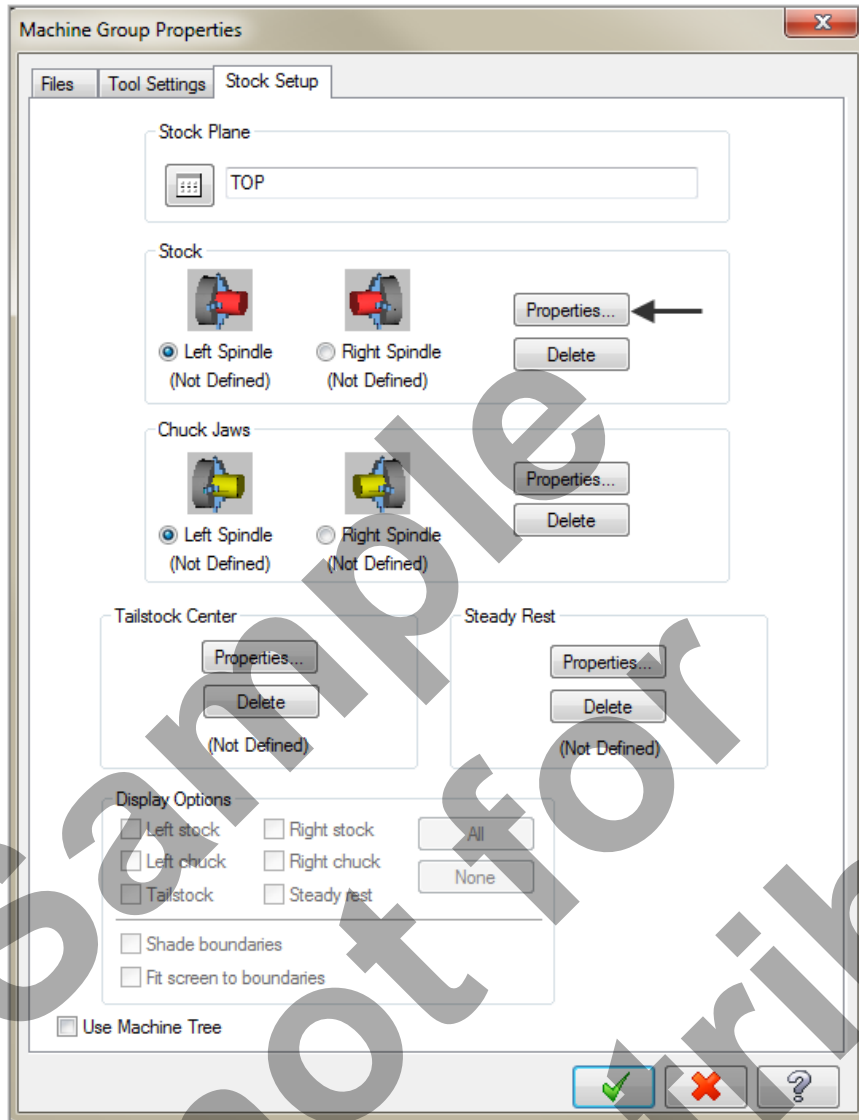

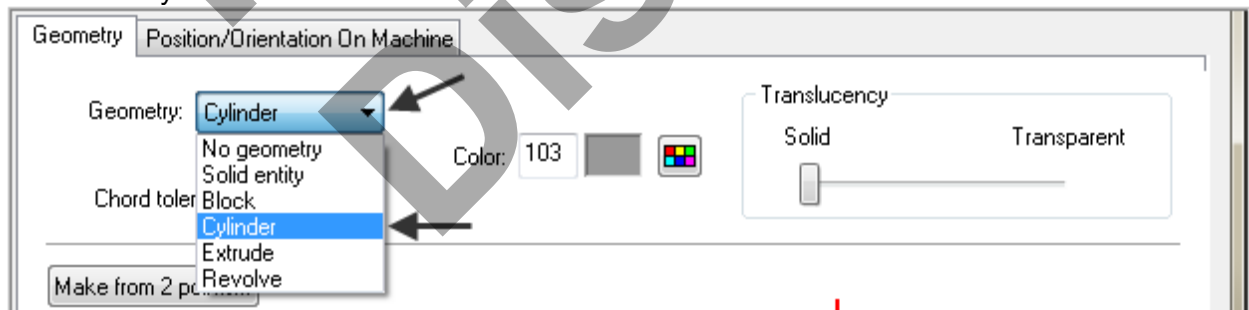

8. In the **Machine Component Manager-Stock** window click on the Geometry button and select Cylinder as shown below:

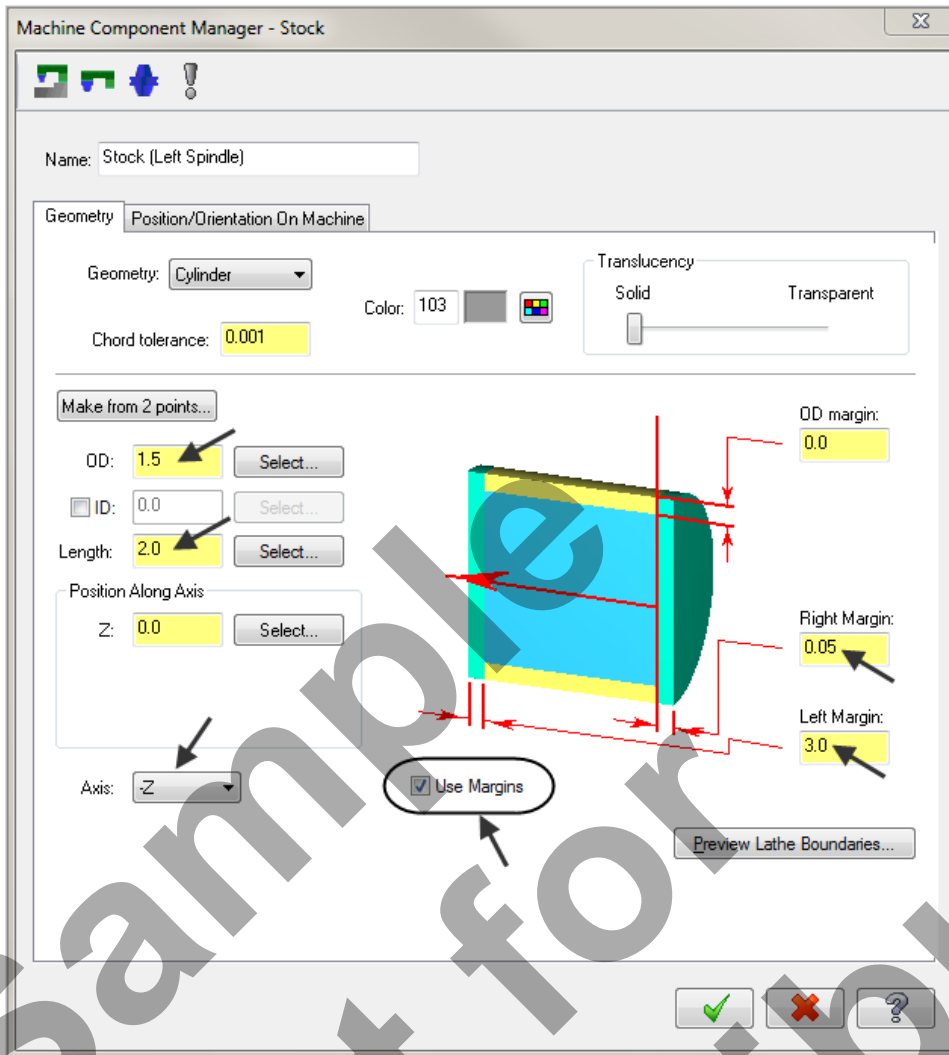

Mastercam Training Guide

9. In the **Stock** setup activate **Use Margins** and set the values as shown below. Note that **Axis** is set to **-Z**.



10. Click on the **OK** icon  to complete this feature.
11. Still on the Stock Setup page activate **Fit screen to boundaries**.

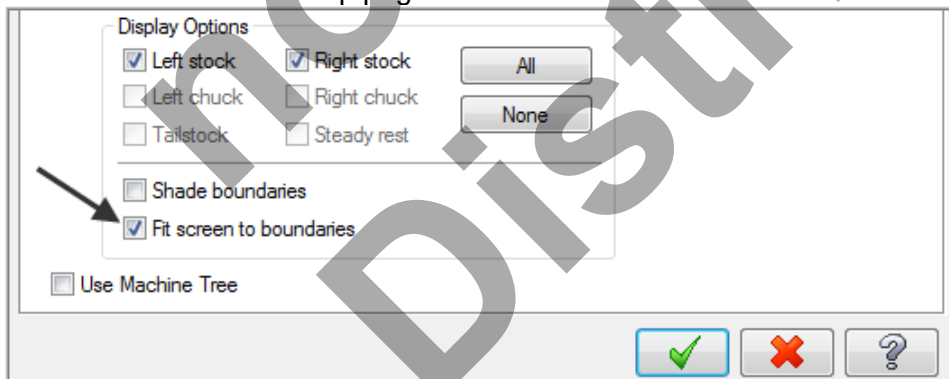

Fit screen to boundaries

Check to determine that the stock, chuck, and tailstock boundaries are included when fitting geometry to the graphics window

12. Select the **Chuck Properties** button in the Stock Setup page as shown in the screenshot below:

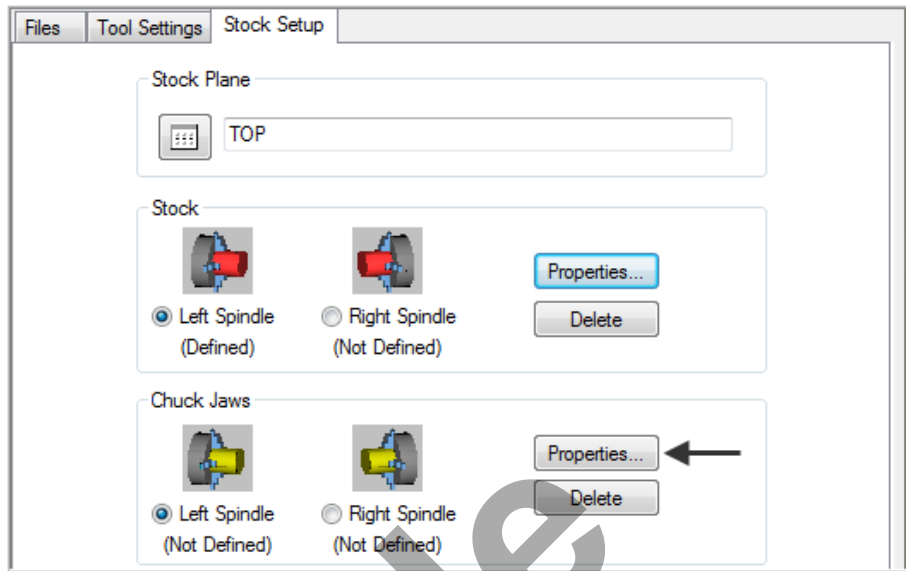

13. In the **Chuck Jaws** setup set the values as shown below:

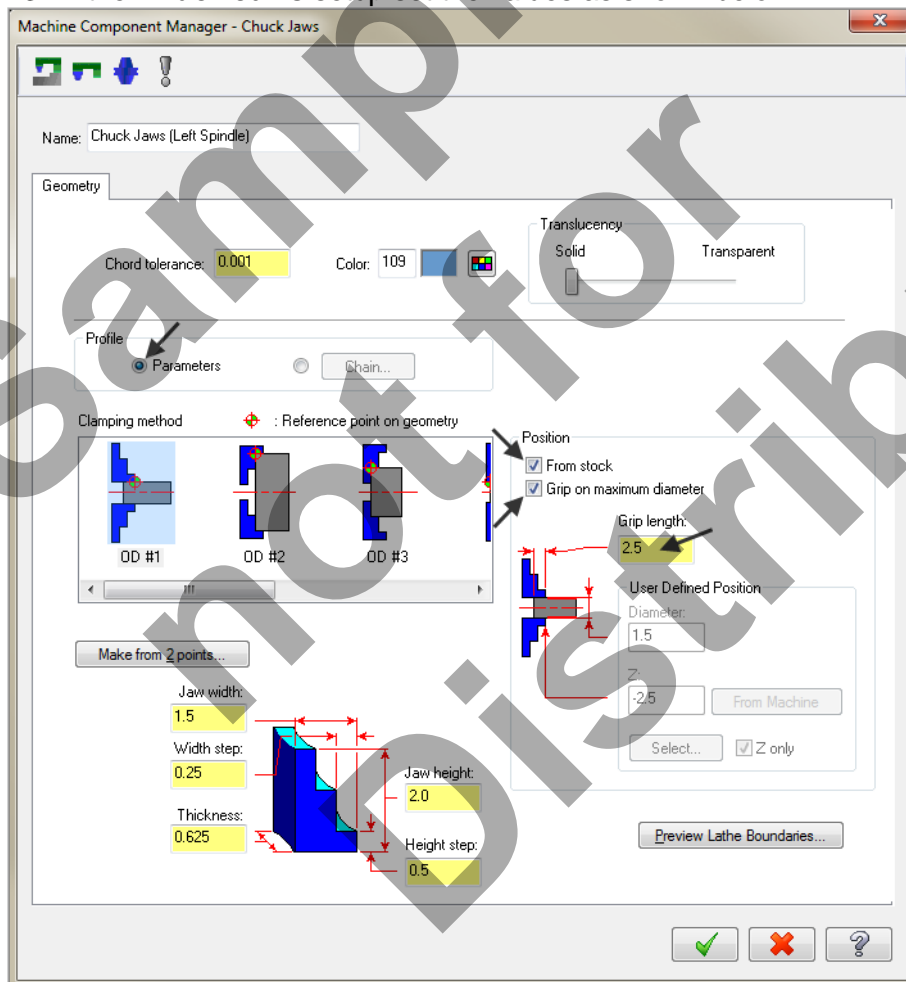

14. Click on the **OK** icon  to complete this feature.

Mastercam Training Guide

15. Click on the **Tool Settings** page:

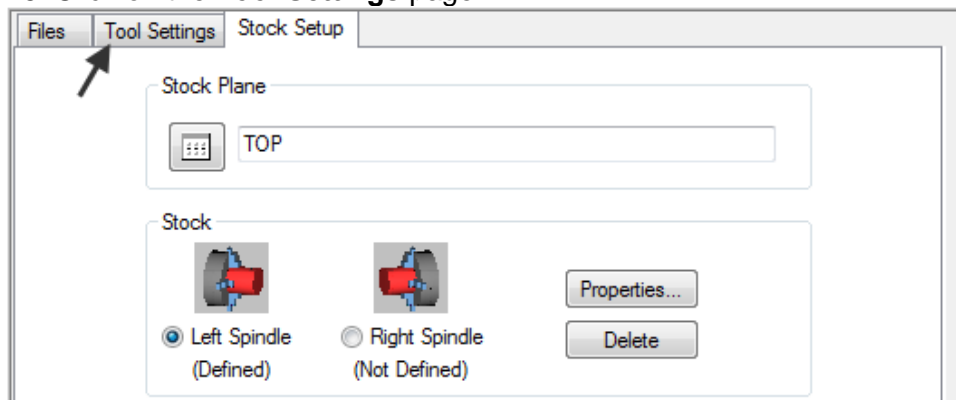

16. Make changes as shown below then click on the **Select** button:

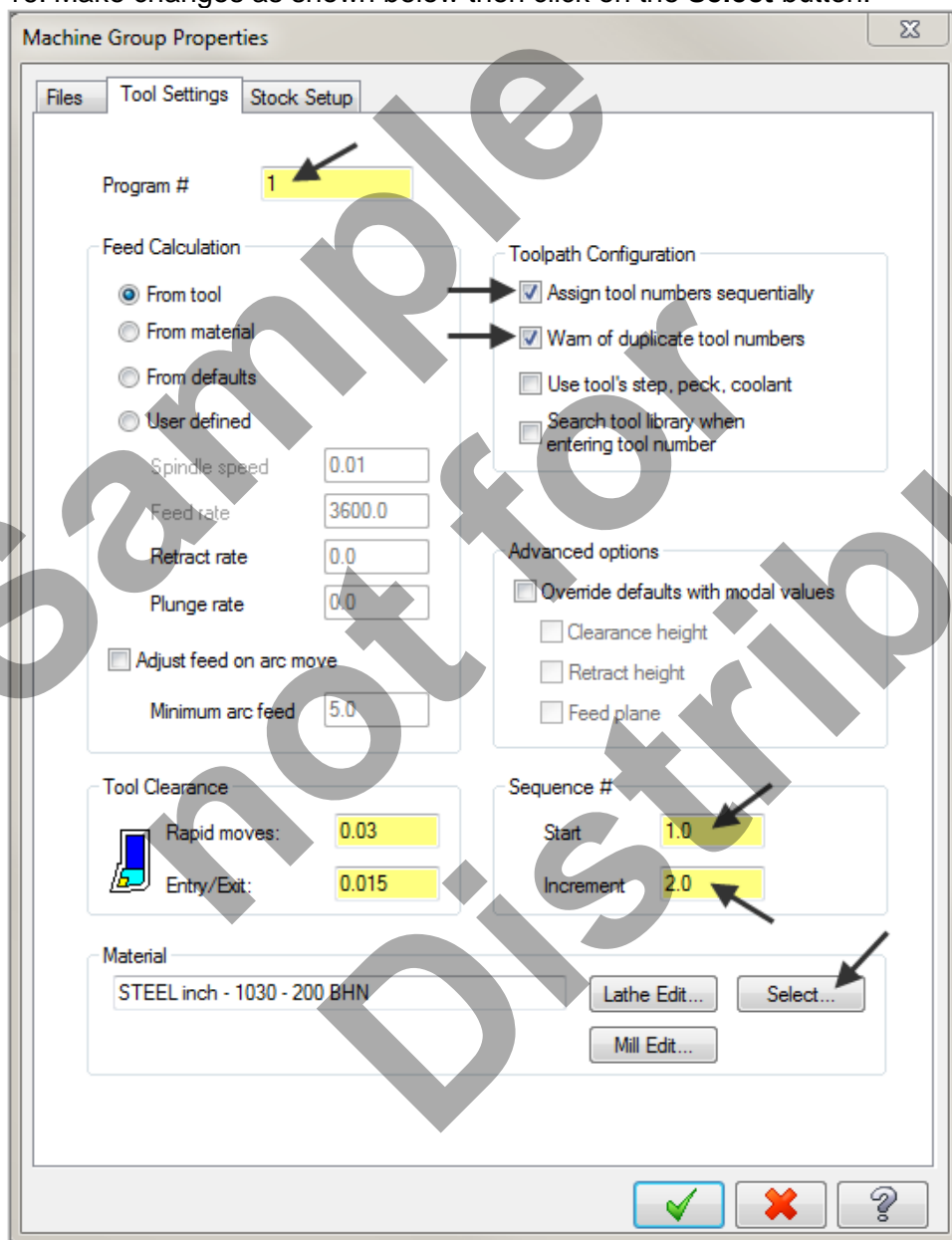

17. Select **Lathe – library** from the drop down **Material List** dialog box as shown below:

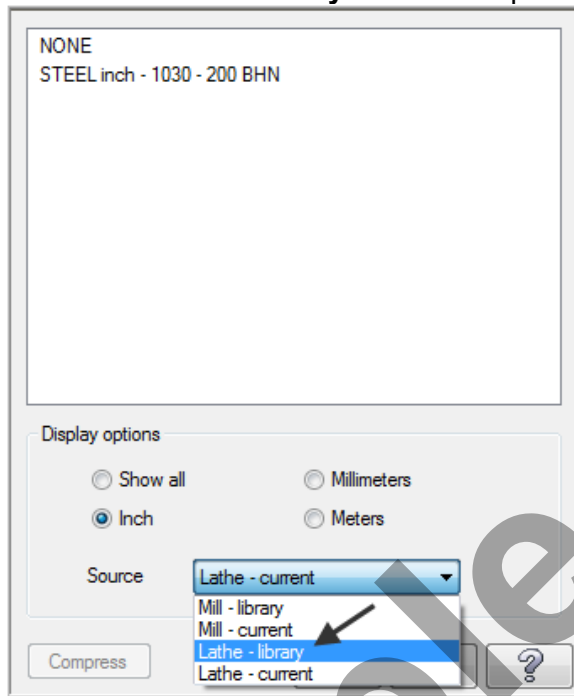

18. Select **ALUMINIUM inch - 6061** from the Default Materials list.

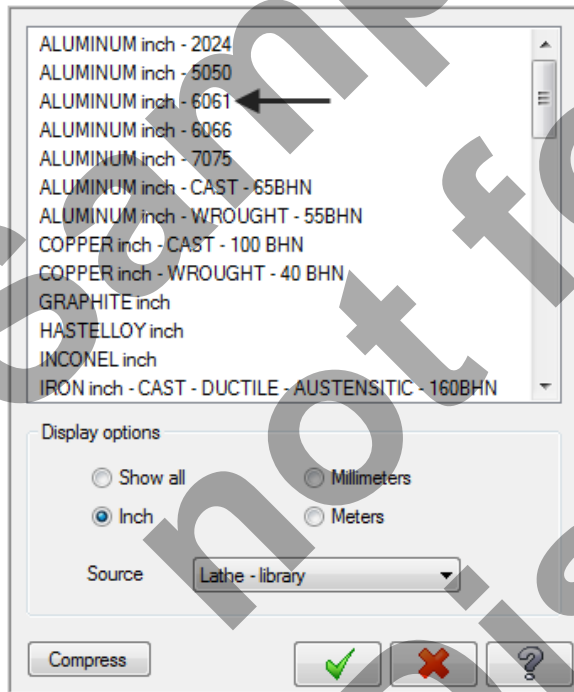

19. Select the OK button .

20. Select the OK button  again to complete this Stock Setup function.

Mastercam Training Guide

21. Select the **screen Fit** icon.



Notice the stock setup outline as indicated by broken lines as shown below:

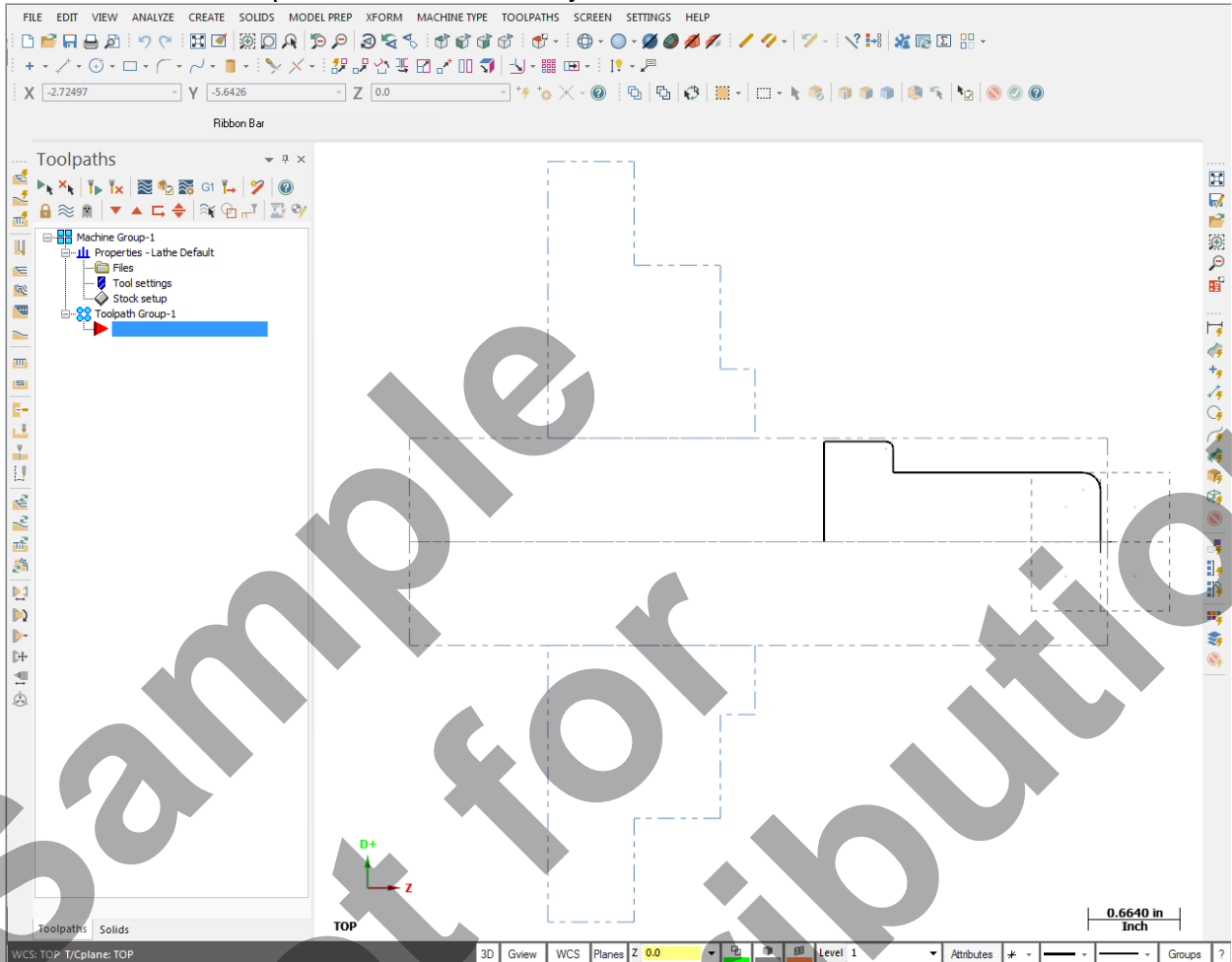

TASK 7:

FACE THE FRONT OF THE PART:

☞ In this task you will use a facing tool to face the front of the part in one cut.

1. If required select the **Fit** icon as shown:



2. From the menu bar select **TOOLPATHS>Face...**

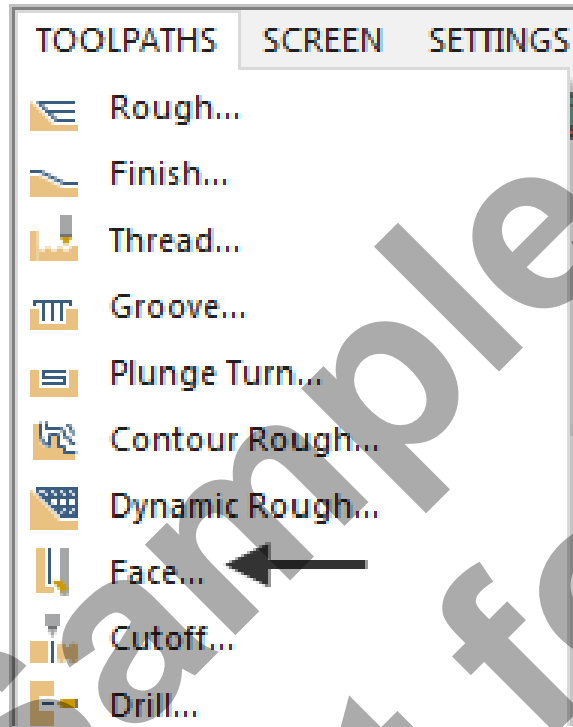

3. When prompted to “**Enter new NC name**” select the OK button to accept LATHE-LESSON-1 as shown below:

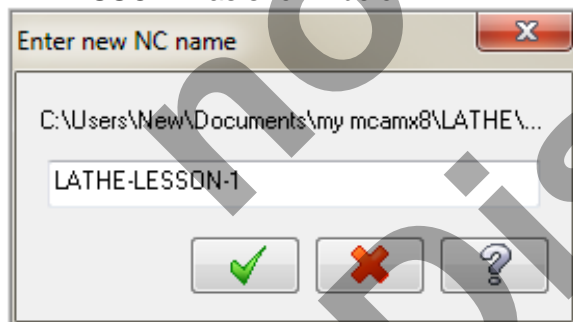

Mastercam Training Guide

- After selecting the OK button you are confronted with **Toolpath parameters** page. The first task here will be to select **Tool #1 an OD Rough- Right – 80 deg.**
- Click on **Tool #1 OD ROUGH RIGHT** and make changes in the Toolpath parameters page as shown below:

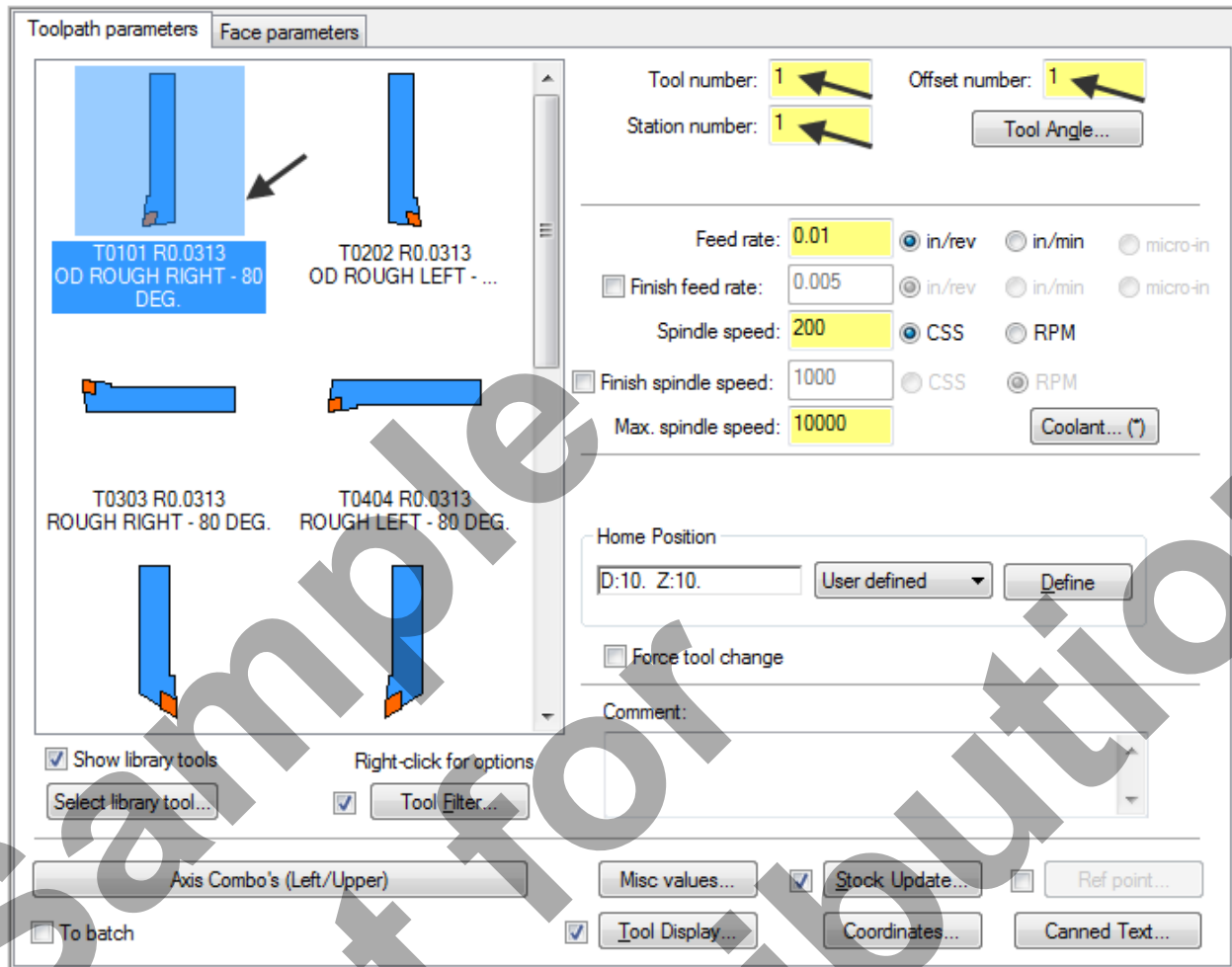

- Select the **Face parameters** page as shown below:

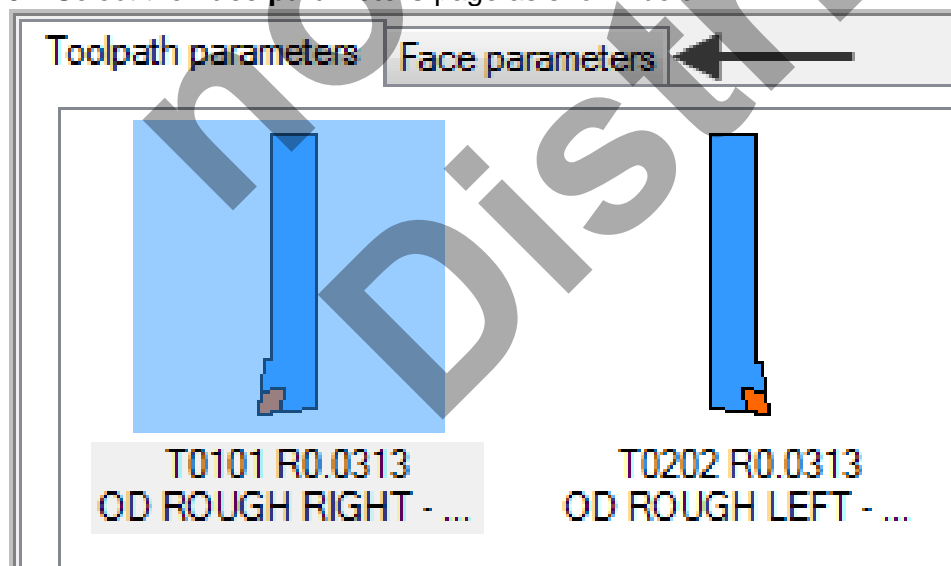

6. Make changes as shown below:

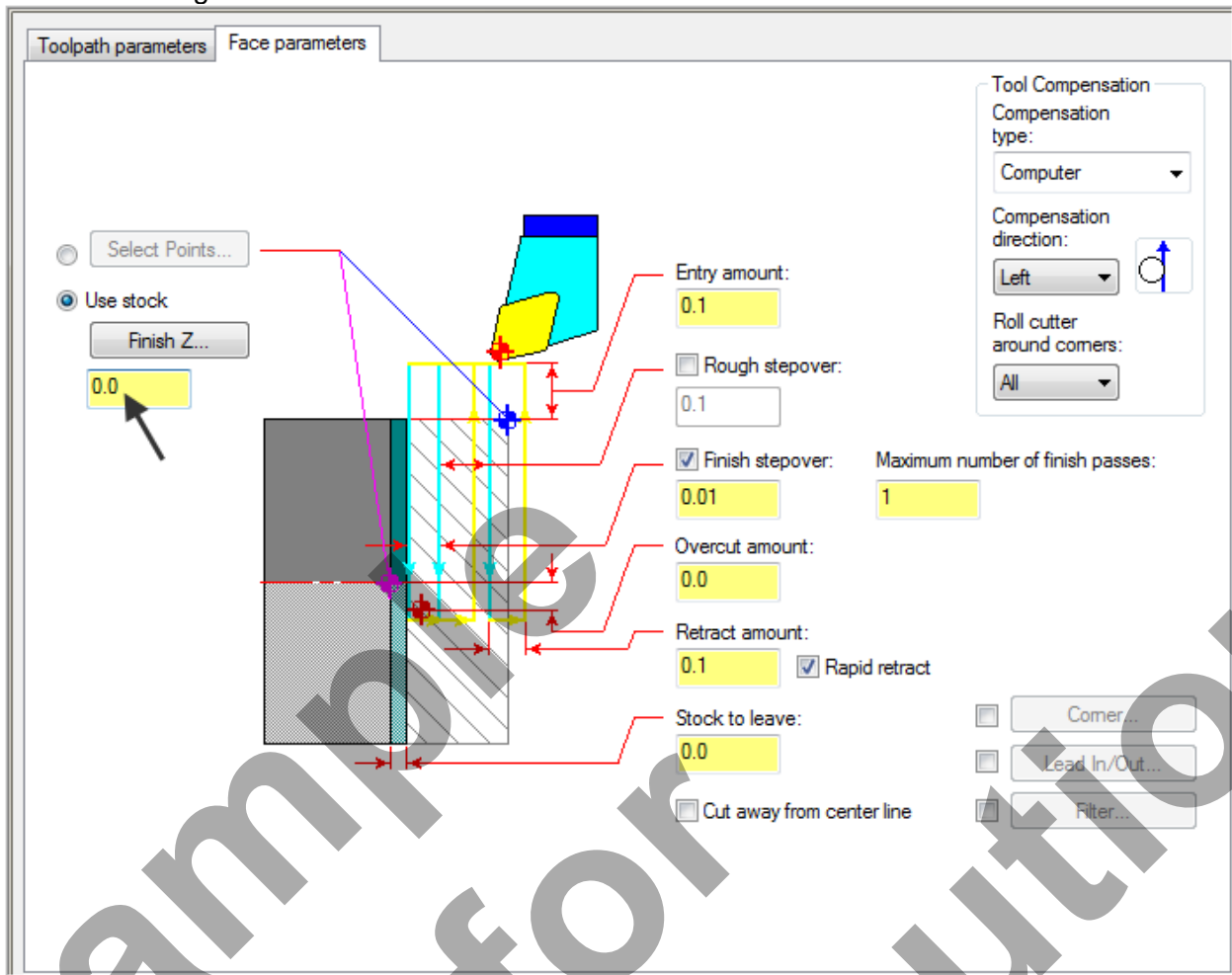

7. Select the OK button  to complete this **Lathe Face** operation.

Mastercam Training Guide

8. Your screen should look like the image below:

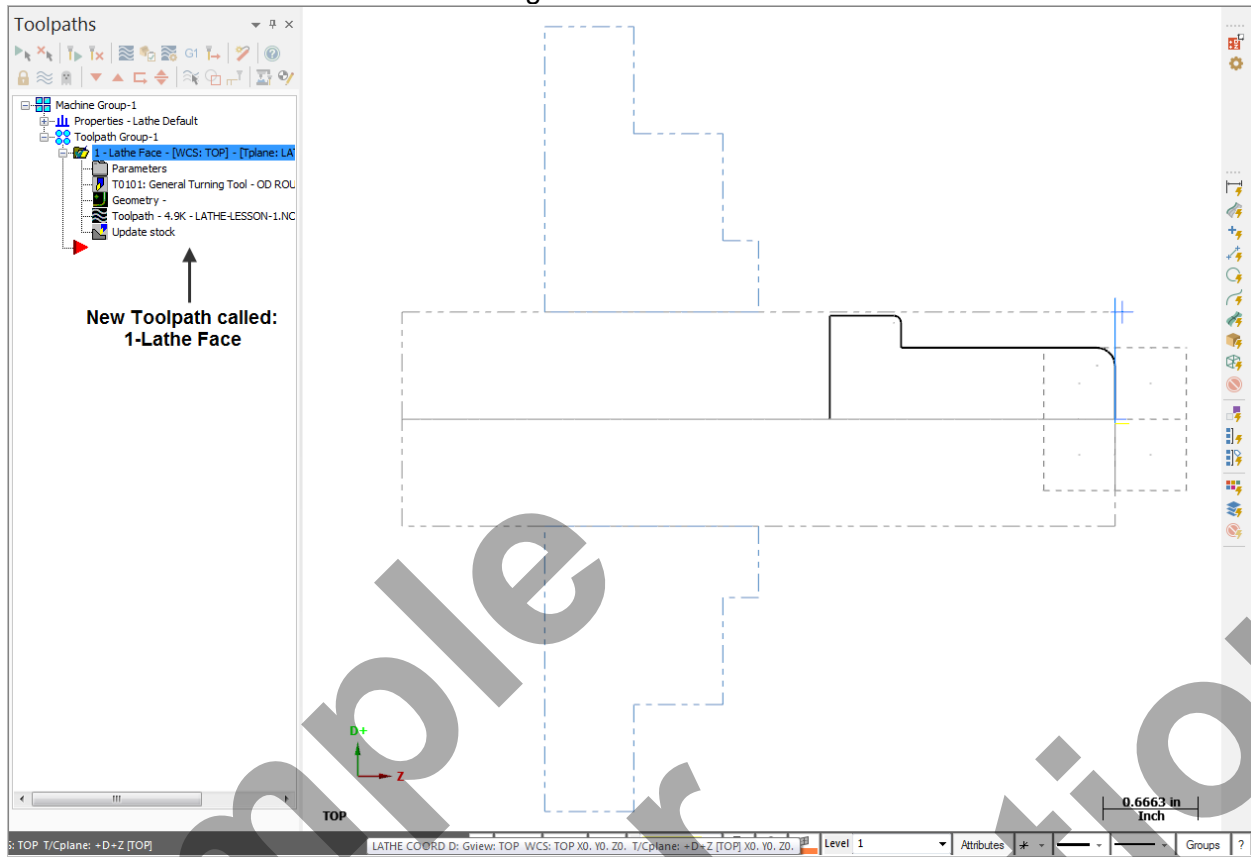

➤ Note: the new Toolpath called **1-Lathe Face**. This is where all the toolpath information is kept. If changes are required to this toolpath just click on the parameter icon



and the Screens from steps 4 through 8 will be available. This is handy in case a mistake was made in setting the toolpath parameters or in case a modification needs to be made.

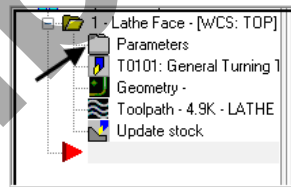

9. To experience how this works, click on the **Parameters** icon

10. Click on the **Toolpath parameters** tab or the **Face parameters** tab as shown below:

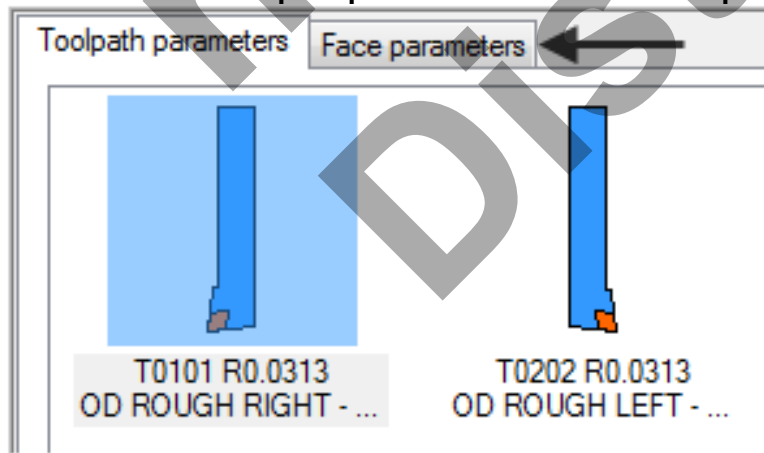

- As you can see, all the toolpath settings (parameters) are available in case a change or correction is required.

11. Click on the OK button  to return to the main screen.

TASK 8: ROUGH THE OUTSIDE DIAMETERS

- In this task you will use the same tool as used for the previous facing operation **Tool #1 an OD Rough- Right – 80 deg.**

1. From the menu bar select **TOOLPATHS>Rough...**

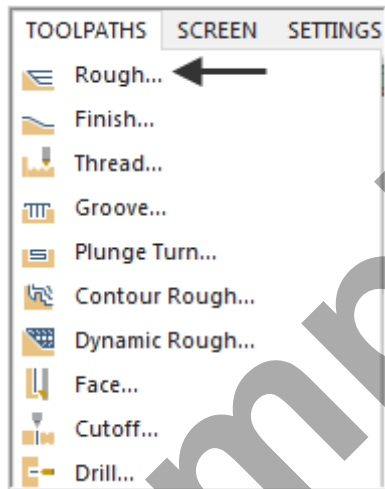

2. In the **Chaining** window Chaining mode is set to **Partial** by default.

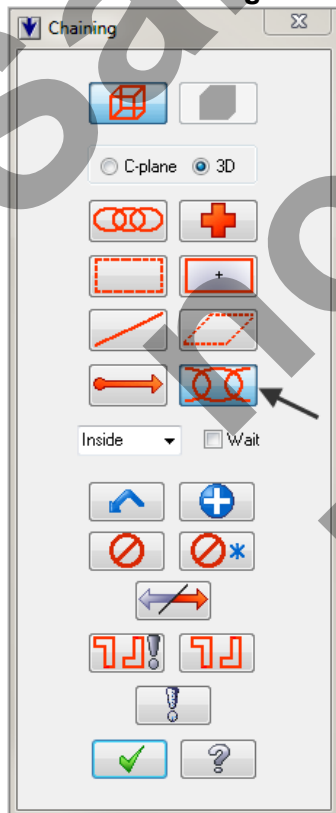

Mastercam Training Guide

3. Select **Arc 1** as the start of the **Partial chain**.

After you have selected the arc **ensure** that the arrows are pointing up and to the left of the part

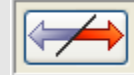

If it is not select the reverse button in the Chaining dialog box:

4. Then select **Line 2** as the end entity in this chain.

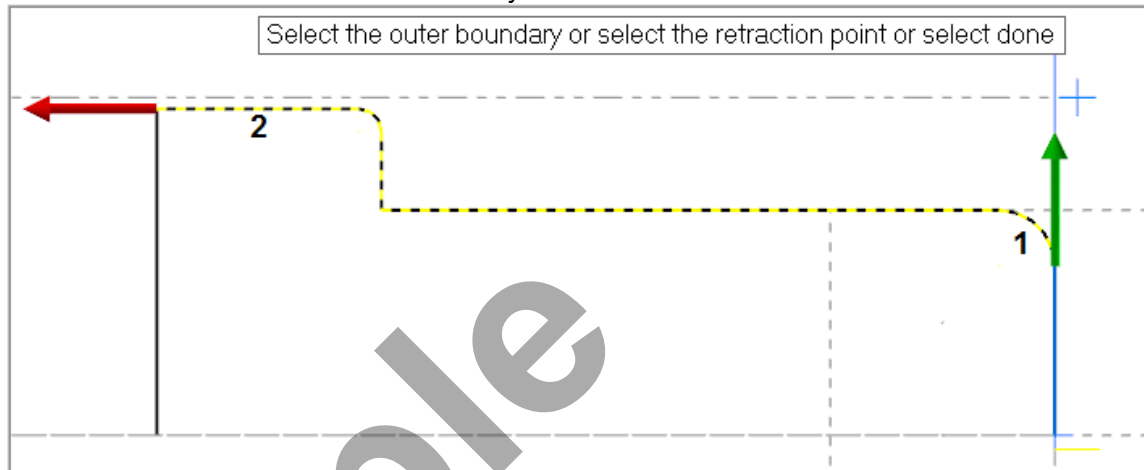

5. Select the **OK** button  to exit the Chaining dialog window.
6. In the **Toolpath parameters** page select the same tool used to face the part **Tool #1 OD ROUGH RIGHT** and make sure the settings are the same as shown below:

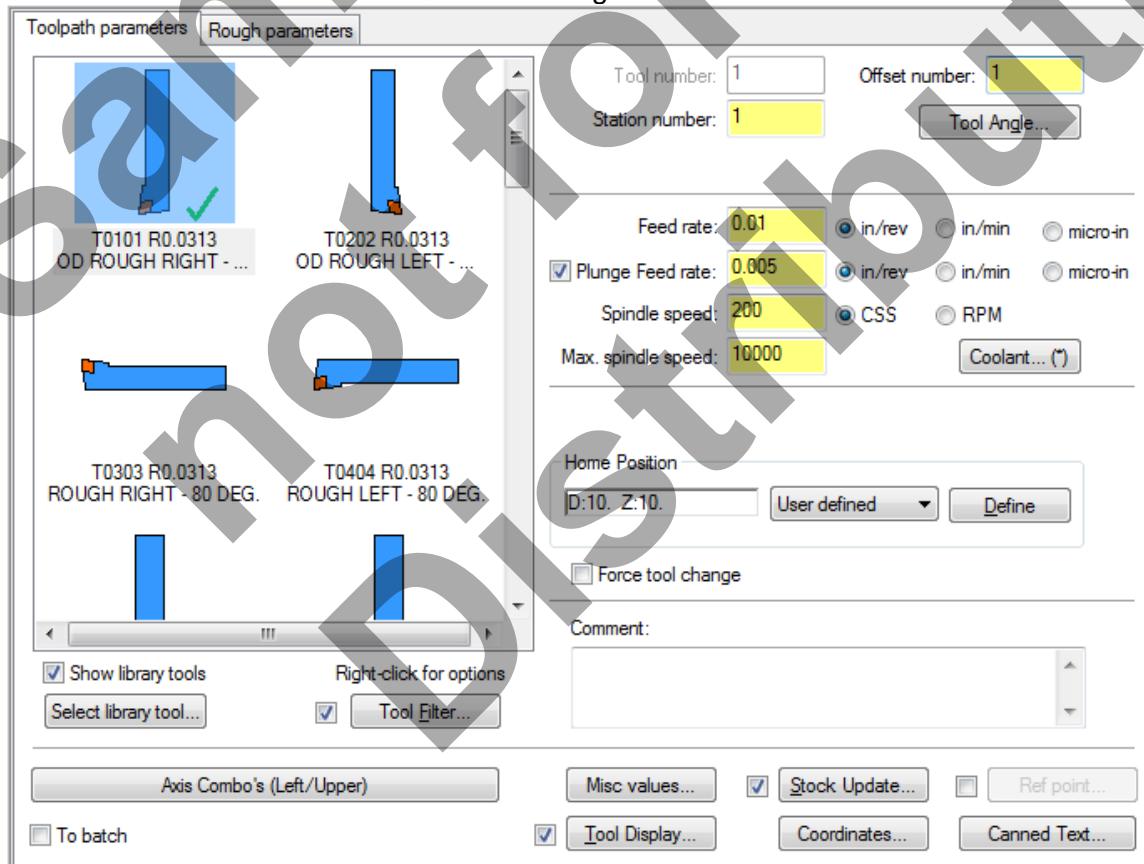

7. Select the **Rough parameters** page and make changes as shown below:

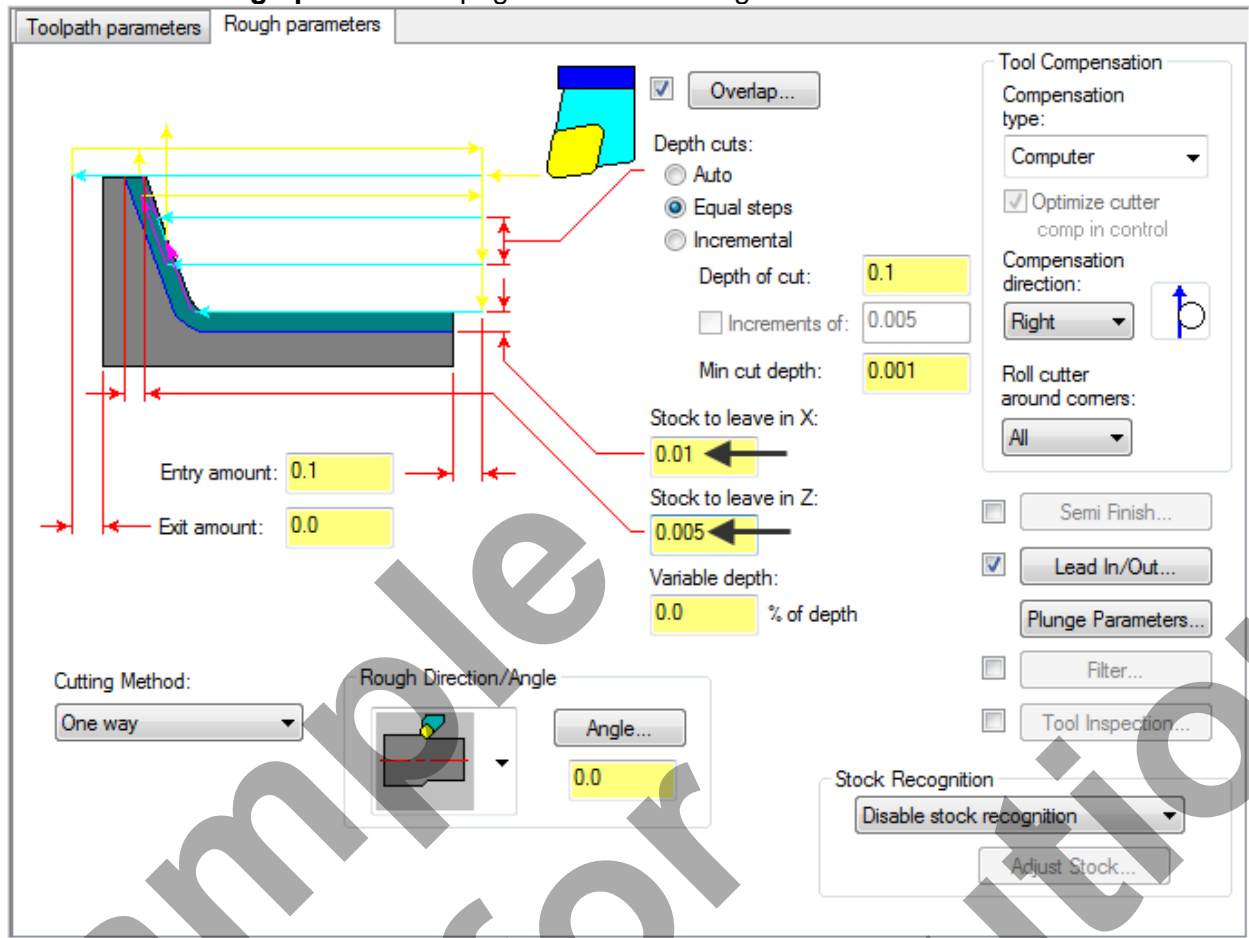

8. Select the **Lead In/Out** button select the **Lead out** page and extend the contour by .2 as shown below:

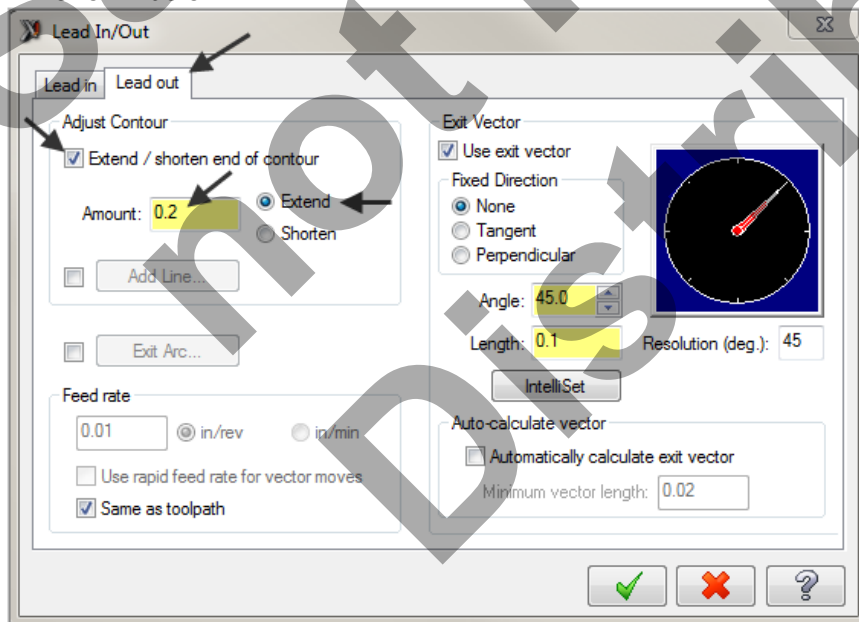

9. Select the **OK** button  to exit this function.

10. Select the **OK** button  to exit Rough Parameters.

**TASK 9:
FINISH THE OUTSIDE DIAMETERS**

☞ In this task you will finish the outside diameters in one cut using **Tool #1 an OD Rough-Right – 80 deg.**

1. From the menu bar select **TOOLPATHS>Finish...**

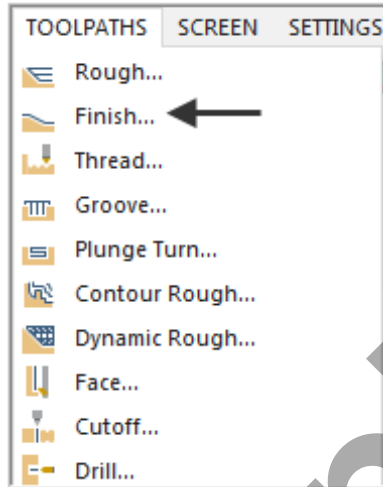

2. Select **Last** in the Chaining dialog box.



3. Select the **OK** button  to complete the selection.

- Select the same tool used to rough the part; **Tool #1 OD Rough Right** tool from the tool list and make changes as shown below if required:

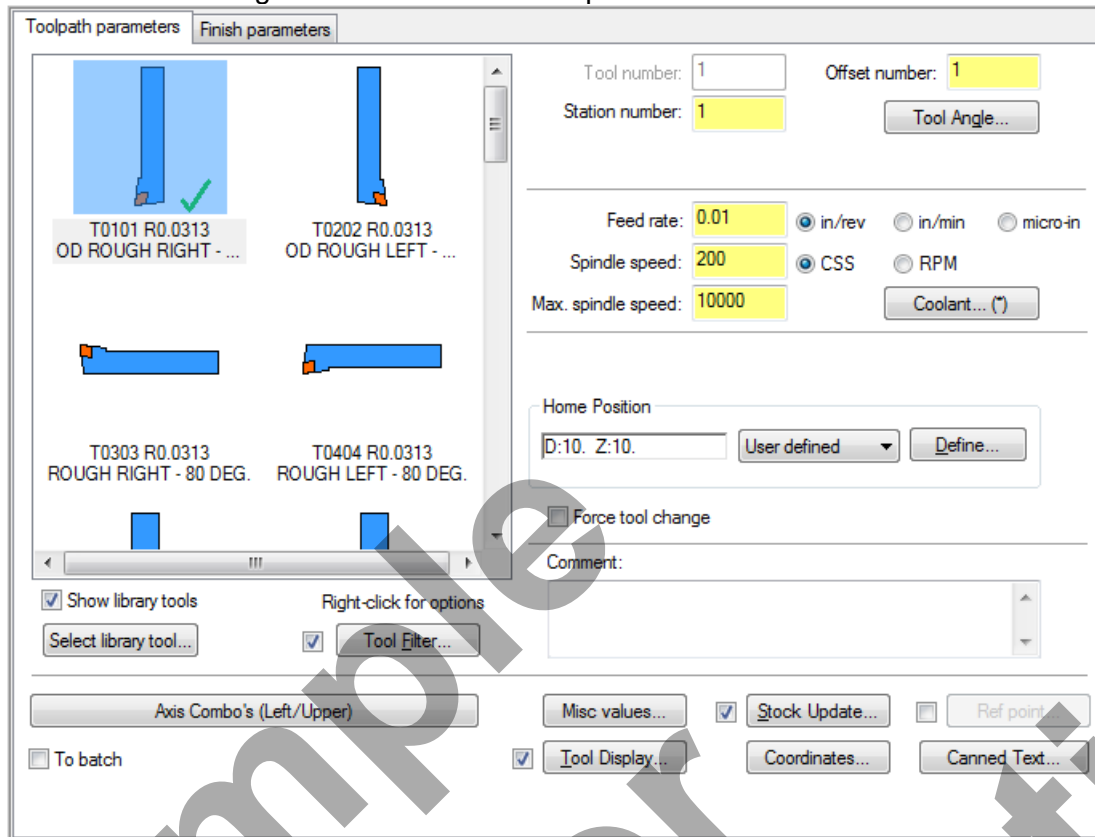

- Select the **Finish parameters** page and make changes as shown below:

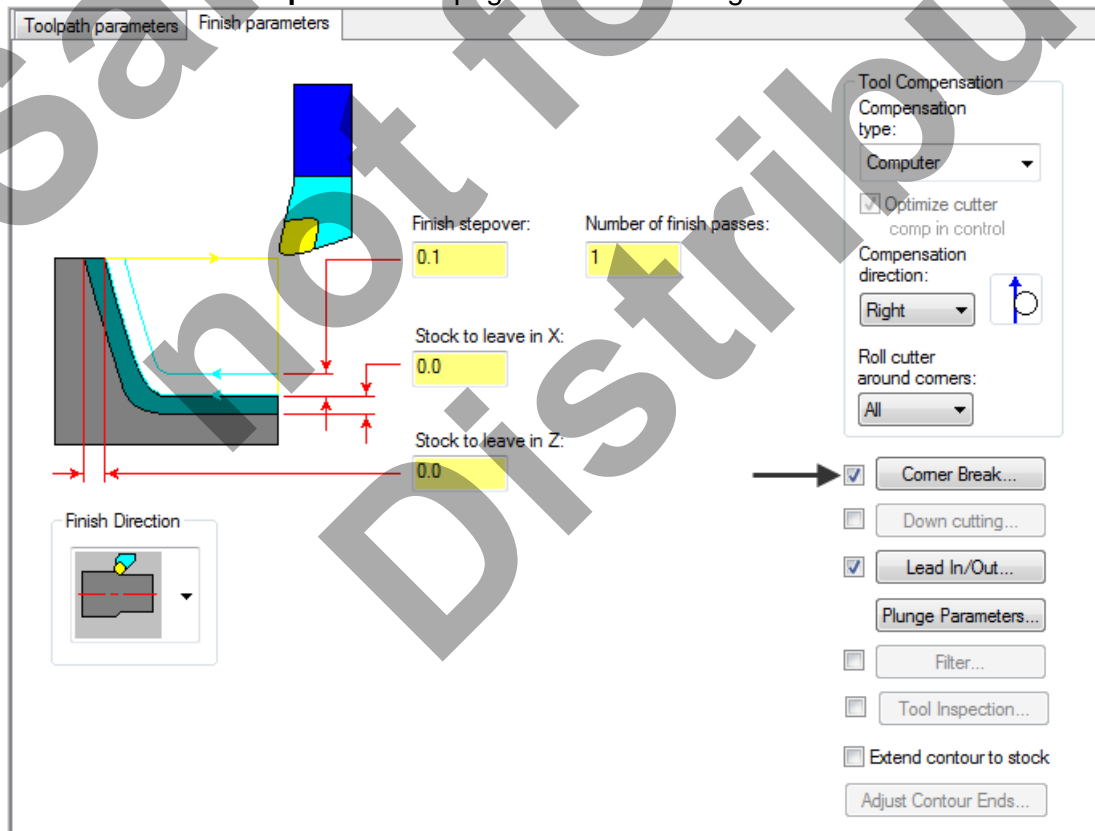

Mastercam Training Guide

Corner Break: Select the check box to automatically create radii or chamfers on all outer corners of the toolpath. Click the button to edit the corner break settings.

6. Select the **Corner Break** button and make changes as shown below if required:

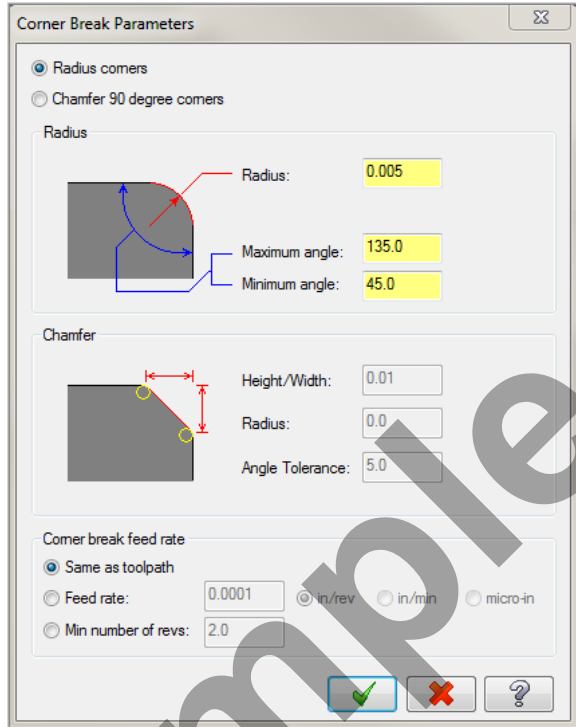

Corner Break

Use this dialog box to automatically create radii or chamfers on all outer corners of lathe finish toolpaths. You can also set the feed rate when the tool creates the radii or chamfers.

7. Select the OK button  to complete this feature.

8. Select the **Lead In/Out** button select the **Lead out** page and extend the contour by .2 as shown below:

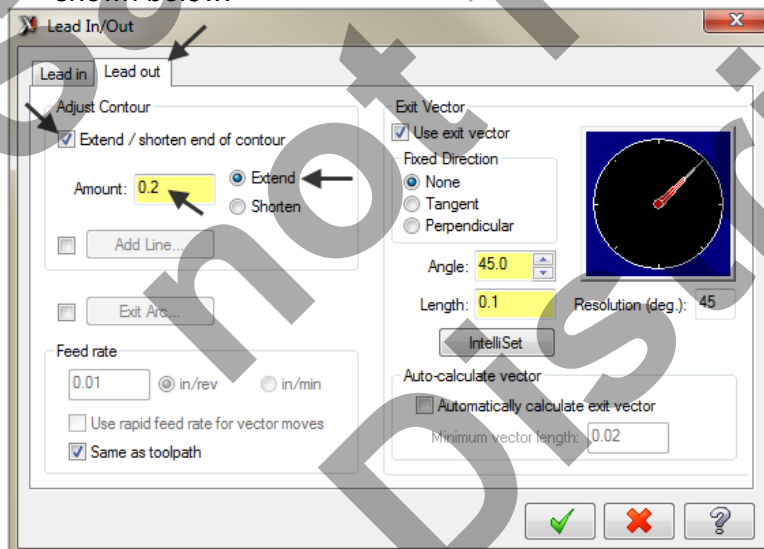

9. Select the OK button  to exit this function.

10. Select the OK button  to exit **Finish** parameters.

**TASK 10:
CUTOFF THE PART**

☞ In this task you will cutoff the part using a .125 wide cutoff tool.

1. From the menu bar select **Toolpaths>Cutoff...**

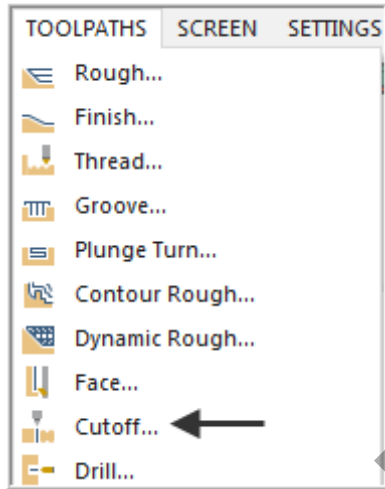

2. Select the **Alt** key and the **T** key on the keyboard to hide the toolpath lines.

Toolpath Lines visible:

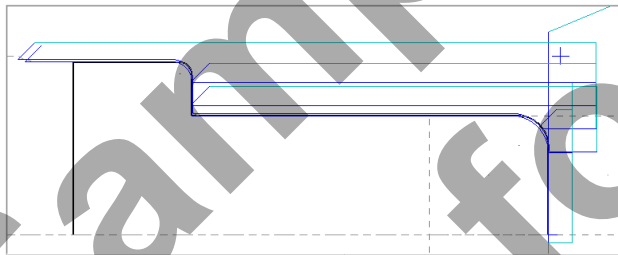

Press Alt T to hide toolpath Lines:



3. Move the cursor over the corner (where **Line 1** and **Line 2** meet) until the visual cue for End point displays and then click on this point as shown below:

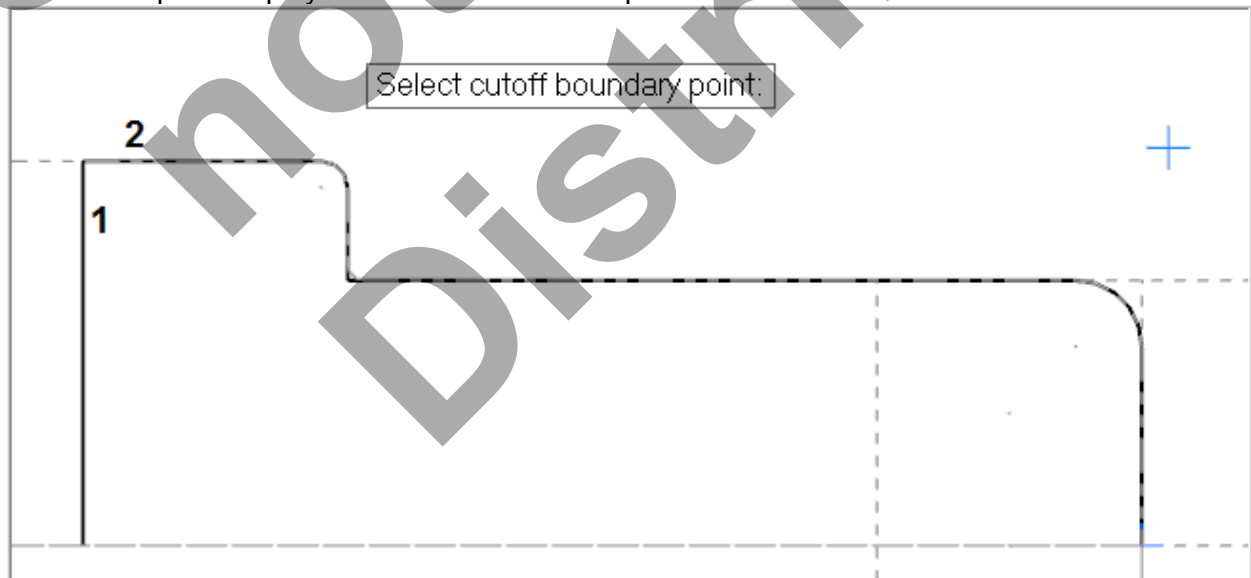

Mastercam Training Guide

4. Scroll down if required in the tool window and select the **OD Cutoff Right Width .125** tool and make changes as shown below in the **Toolpath parameters** page:

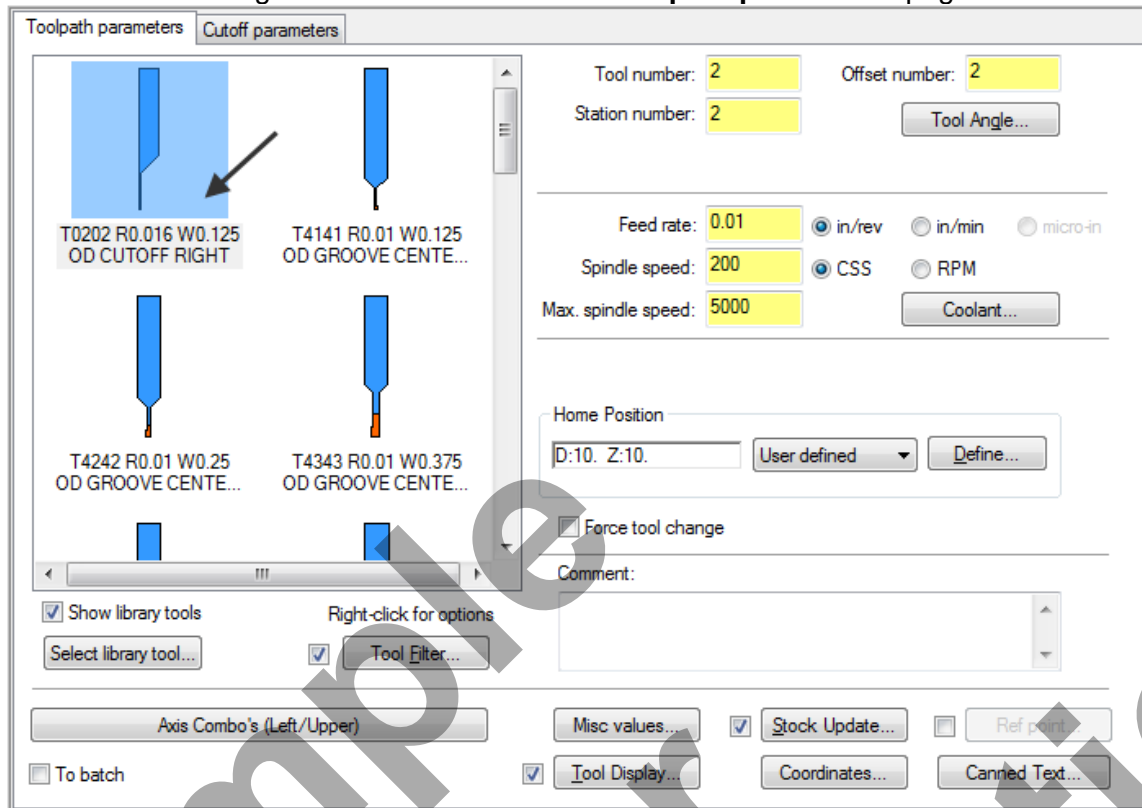

5. Select the **Cutoff parameters** page and make changes if required as shown below:

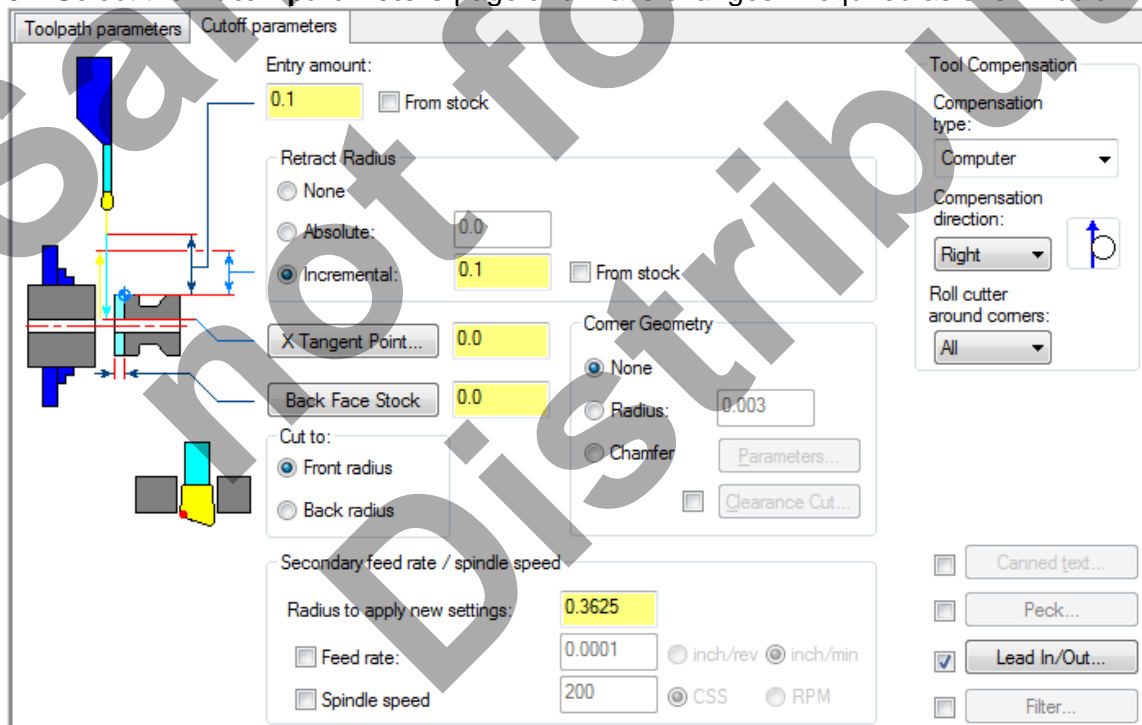

6. Select the **OK** button  to exit **Cutoff parameters**.

TASK 11: BACKPLOT THE TOOLPATH

- In this task you will use Mastercam's Backplot function to view the path the tools take to cut this part.
- Backplot will enable you to review the cutting motions and identify any problem areas when cutting the part.
- When the toolpaths are being Backplotted Mastercam displays tool path information on the right of the screen. Information such as the current tool position in X and Z coordinates.
- **For more information on Backplot see the Tips and Techniques section on the multimedia DVD supplied with this text.**

1. To pick all the operations to backplot pick the **Select All** icon  circled below:

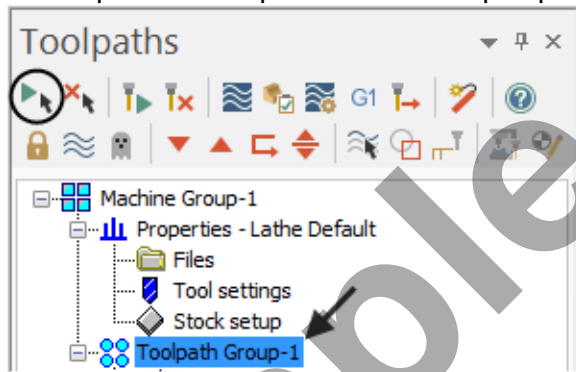

- Another method to **Select all** the operations is by clicking on the **Toolpath Group-1** in the Toolpaths Manager as shown by the arrow above.

2. The next step is to select the **Backplot selected operations** icon shown below:

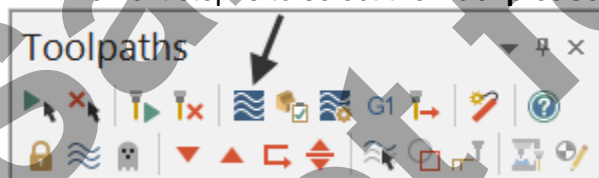

3. **Maximize** the Backplot/Verify window if required.
4. Select the **Home** Tab if required.



5. Activate the options shown below in the **Visibility** section of the Home tab.

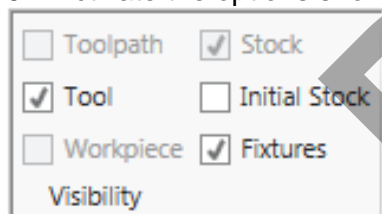

Initial Stock

This displays the stock before machining.
Click to cycle through three states:

On
Translucent
Off

Tool

This displays the tool during Backplot or Verification. Click to cycle through three states as mentioned above

Mastercam Training Guide

6. At the top of the screen select the **View** tab, the **Isometric** icon and then select **Fit**.

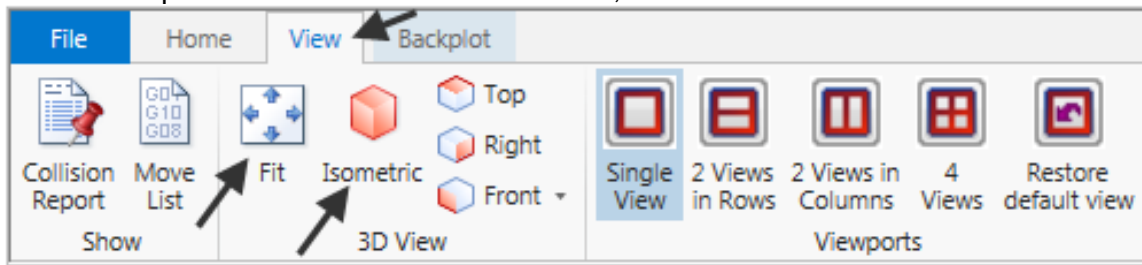

7. Click on the **Backplot** tab at the top left of the screen

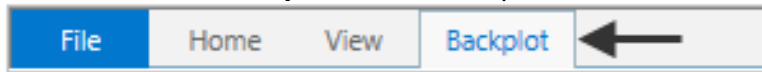

8. Activate the **Both** option in the Toolpath section of the Backplot tab.

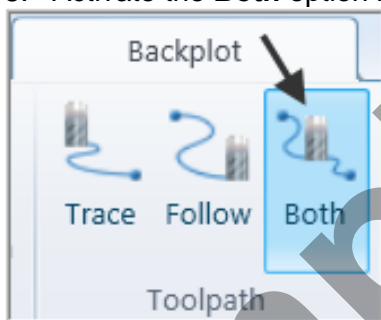

Both

This displays the entire toolpath and the tool as it travels over the displayed toolpath.

9. In the lower right corner of the screen now set the run **Speed** to slow by moving the slider bar pointer over to the left as shown below.



10. Now select the **Play Simulation** button to review the toolpaths.



11. Now hit the **rewind** button on the controls to move back to the **start** position.

12. After reviewing the Backplot of the toolpaths select the **Close** button  in the top right hand corner to exit Backplot.

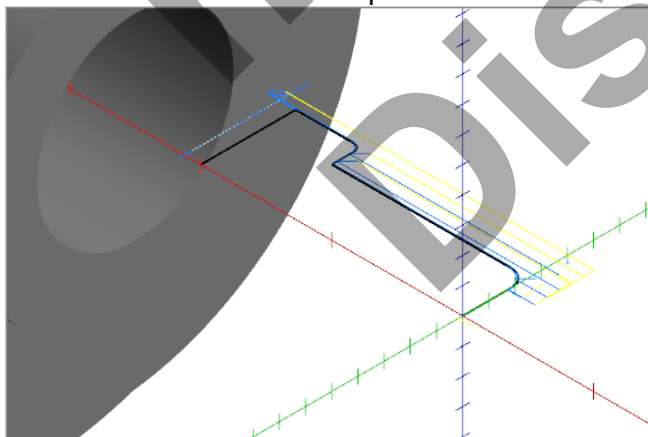

**TASK 12:
VERIFY THE TOOLPATH**

- ☞ Mastercam's Verify utility allows you to use solid models to simulate the machining of a part. The model created by the verification represents the surface finish, and shows collisions, if any exist.
- ☞ This allows you to identify and correct program errors before they reach the shop floor.
- ☞ Backplot and Verify are very similar. The differences between these two functions are that Backplot offers basic simulation options. Whereas Verify offers material removal, collision checking and precision control.
- ☞ **For more information on Verify see the Tips and Techniques section on the multimedia DVD supplied with this text**

1. In the **Toolpaths Manager** pick all the operations to verify by picking the **Select All** icon



2. Select the **Verify selected operations** icon shown below:

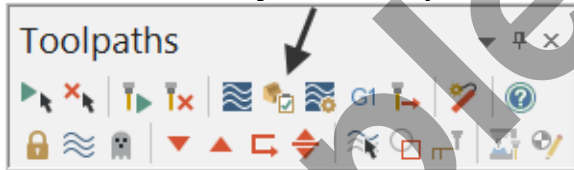

3. **Maximize** the Backplot/Verify window if required.

4. Now select the **Home** Tab if required.



5. Activate the options shown below in the **Visibility** section of the Home tab. **Initial Stock** not activated.

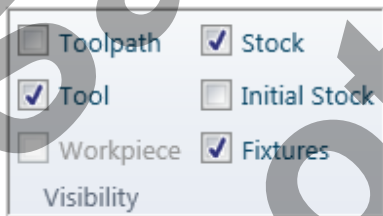

6. Activate the **Color Loop** to change the color of the tools for the verified part.

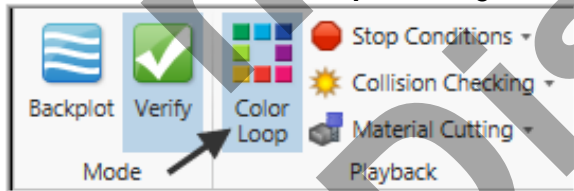

Color Loop
Changes the color of the toolpath or cut stock by operation or by tool change.

Choose **File Options** to set the colors.

7. At the top of the screen select the **View** tab, the **Isometric** icon and then select **Fit**.

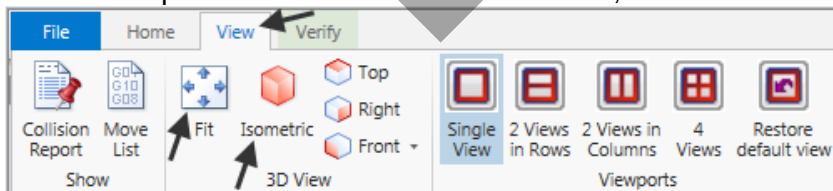



Mastercam Training Guide

8. In the lower right corner of the screen now set the run **Speed** to slow by moving the slider bar pointer over to the left as shown below.

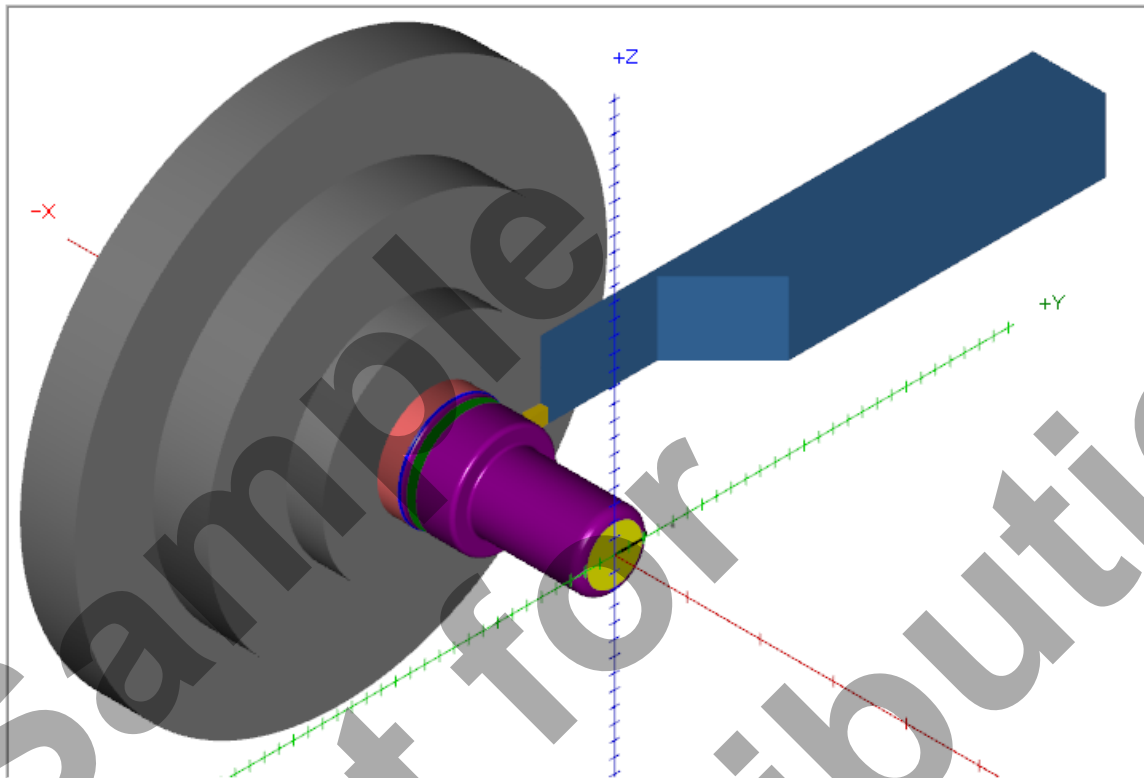

9. Now select the **Play Simulation** button to review the toolpaths.



10. Select the **Close** button  in the top right hand corner to exit Verify.

TASK 13: SAVE THE UPDATED MASTERCAM FILE

1. Select the **save** icon from the toolbar



TASK 14: POST AND CREATE THE CNC CODE FILE

Please Note:

Users of the Mastercam **Home Learning Edition** (HLE) will not be able to Post and Create the CNC code file.

1. Ensure all the operations are selected by picking the **Select All** icon  from the Toolpaths manager.

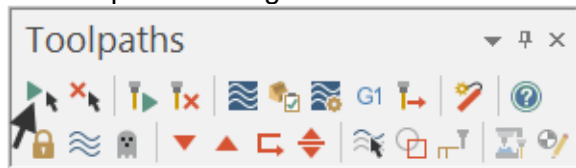

2. Select the **Post selected operations** button from the Toolpaths manager.
 - **Please Note:** If you cannot see **G1** click on the right pane of the Toolpaths manager window and expand the window to the right.

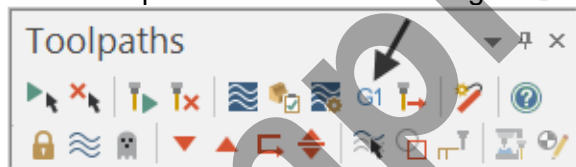

3. In the Post processing window, make the necessary changes as shown below:

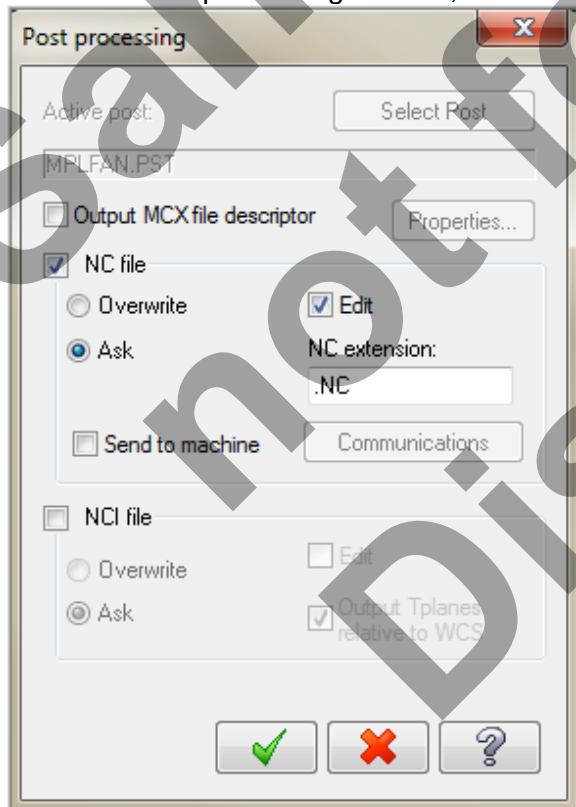

About Post Processing

NC file:

Select this option to save the NC file. The file name and extension are stored in the machine group properties for the selected operation. If you are posting operations from different machine groups or Mastercam files, or batch processing, Mastercam will create several files according to the settings for each machine group.

Edit:

When checked, automatically launches the default text editor with the file displayed so that you can review or modify it.

4. Select the OK button  to continue.
5. Ensure the same name as your Mastercam part file name is displayed in the **NC File name** field as shown below:



File name: LATHE-LESSON-1
Save as type: NC Files (*.NC)

6. Select the **Save** button.
7. The CNC code file opens up in the default editor.



```
LATHE-LESSON-1.NC x
7 (MATERIAL - ALUMINUM INCH - 6061)
8 G20
9 (TOOL - 1 OFFSET - 1)
10 (OD ROUGH RIGHT - 80 DEG. INSERT - CNMG-432)
11 G0 T0101
12 G18
13 G97 S449 M03
14 G0 G54 X1.7 Z0. M8
15 G50 S3600
16 G96 S200
17 G99 G1 X-.0625 F.01
18 G0 Z.1
19 X1.2769
20 Z.2
21 G1 Z.1
22 Z-1.495
23 X1.2975
24 G18 G3 X1.47 Z-1.5813 K-.0862
25 G1 Z-2.2313
26 X1.6114 Z-2.1605
27 G0 Z.2
28 X1.0838
29 G1 Z.1
```

8. Select the  in the top right corner to exit the CNC editor.
9. This completes LATHE-LESSON -1.

LATHE-LESSON-1 EXERCISE

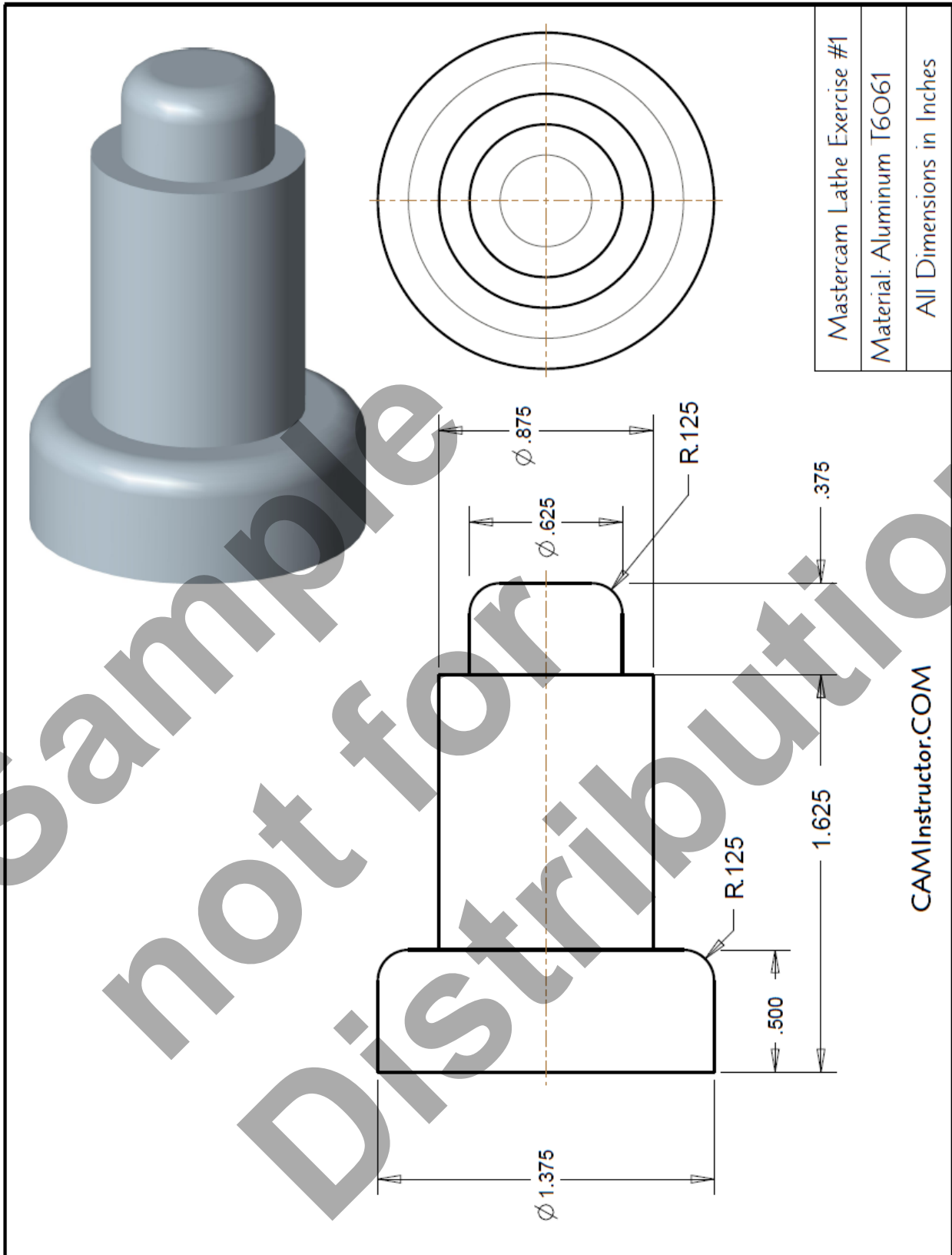

Sample
not for
Distribution